

www.e-rara.ch

Die Hydraulik und die hydraulischen Motoren

Meissner, Georg

Jena, 1878-1880

ETH-Bibliothek Zürich

Persistent Link: <https://doi.org/10.3931/e-rara-106882>

[Tafeln zum ersten Band. Die Hydraulik.]

www.e-rara.ch

Die Plattform e-rara.ch macht die in Schweizer Bibliotheken vorhandenen Drucke online verfügbar. Das Spektrum reicht von Büchern über Karten bis zu illustrierten Materialien – von den Anfängen des Buchdrucks bis ins 20. Jahrhundert.

e-rara.ch provides online access to rare books available in Swiss libraries. The holdings extend from books and maps to illustrated material – from the beginnings of printing to the 20th century.

e-rara.ch met en ligne des reproductions numériques d'imprimés conservés dans les bibliothèques de Suisse. L'éventail va des livres aux documents iconographiques en passant par les cartes – des débuts de l'imprimerie jusqu'au 20e siècle.

e-rara.ch mette a disposizione in rete le edizioni antiche conservate nelle biblioteche svizzere. La collezione comprende libri, carte geografiche e materiale illustrato che risalgono agli inizi della tipografia fino ad arrivare al XX secolo.

Nutzungsbedingungen Dieses Digitalisat kann kostenfrei heruntergeladen werden. Die Lizenzierungsart und die Nutzungsbedingungen sind individuell zu jedem Dokument in den Titelinformationen angegeben. Für weitere Informationen siehe auch [Link]

Terms of Use This digital copy can be downloaded free of charge. The type of licensing and the terms of use are indicated in the title information for each document individually. For further information please refer to the terms of use on [Link]

Conditions d'utilisation Ce document numérique peut être téléchargé gratuitement. Son statut juridique et ses conditions d'utilisation sont précisés dans sa notice détaillée. Pour de plus amples informations, voir [Link]

Condizioni di utilizzo Questo documento può essere scaricato gratuitamente. Il tipo di licenza e le condizioni di utilizzo sono indicate nella notizia bibliografica del singolo documento. Per ulteriori informazioni vedi anche [Link]



47.95: 1/20

Rar 51089: 7 TAF

37

Geschenk
von Herrn Ingenieur
Arn. Bürkli.



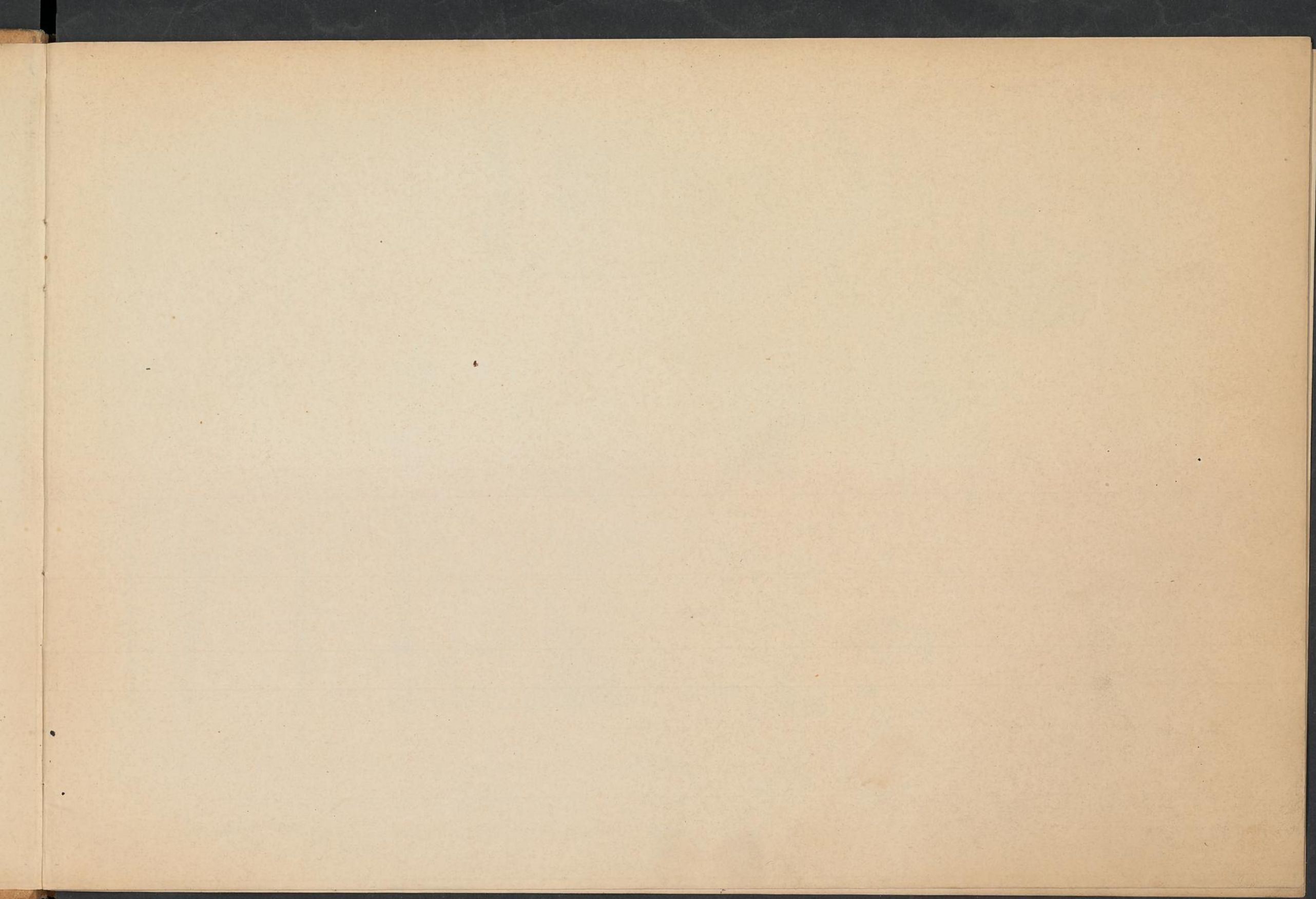

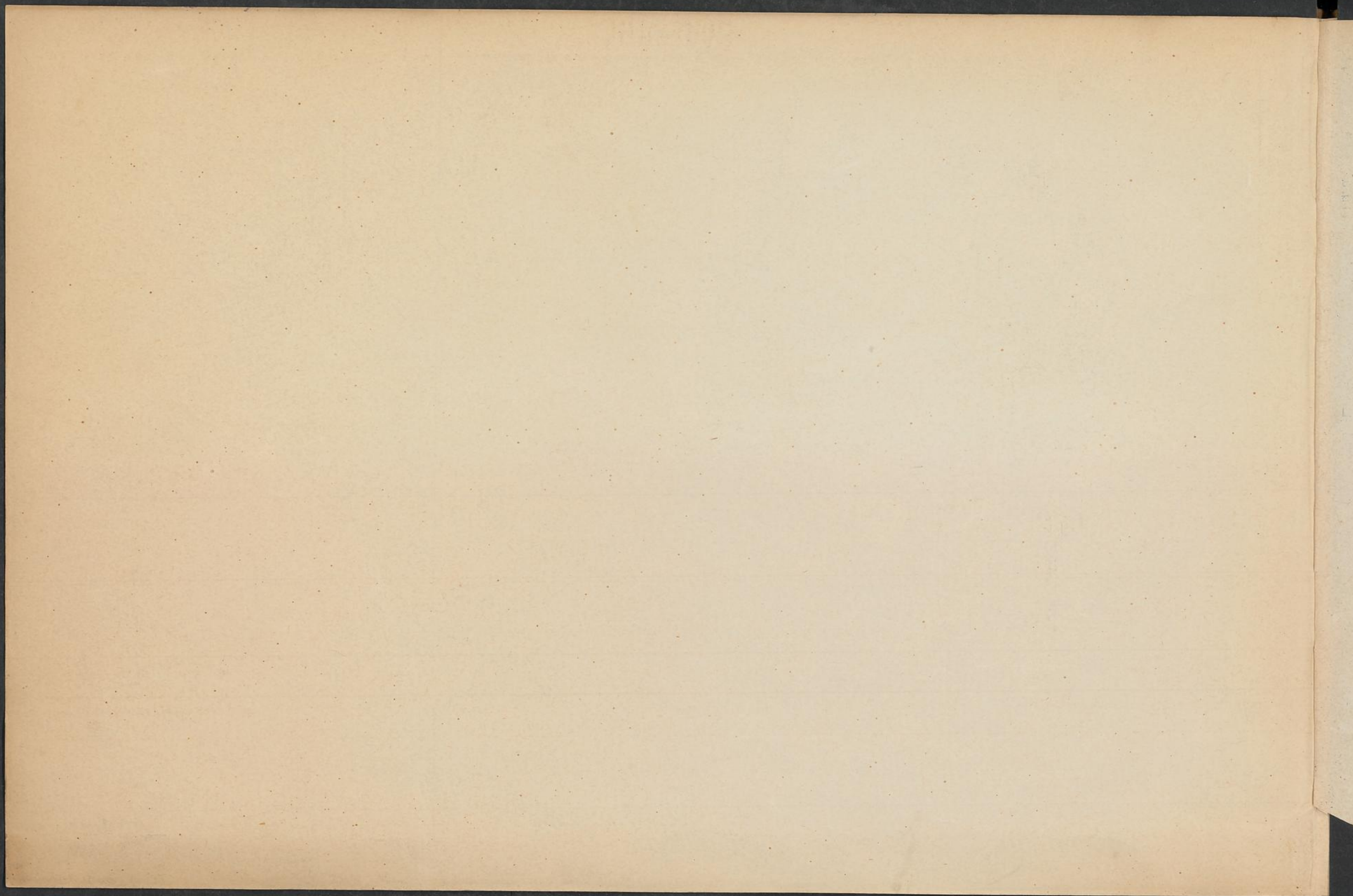

Fig. 1.

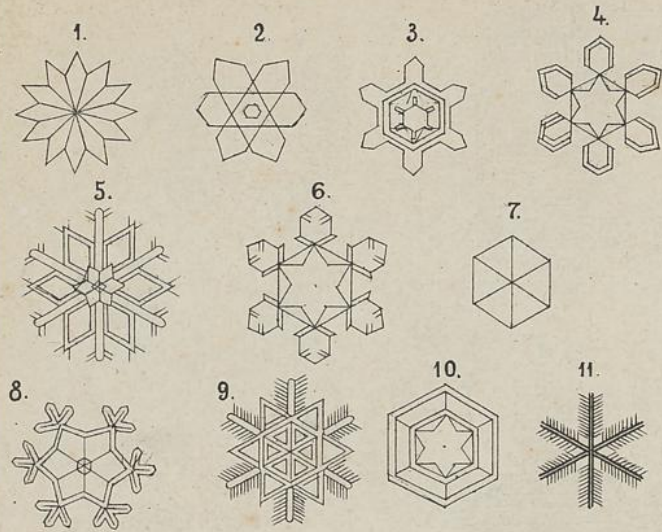

Fig. 2.

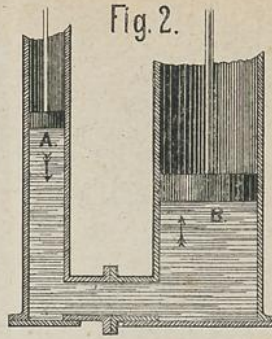

Fig. 4.

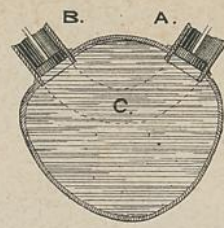

Fig. 3.



Fig. 6.

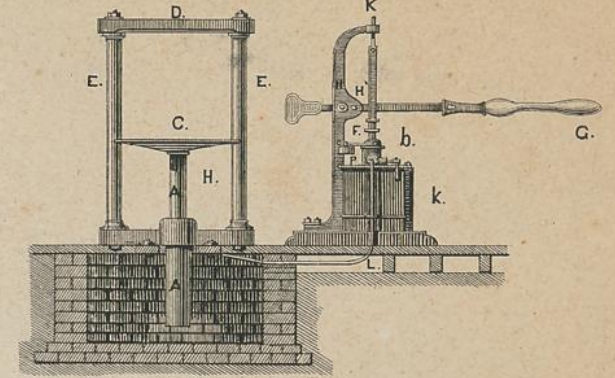

Fig. 5.

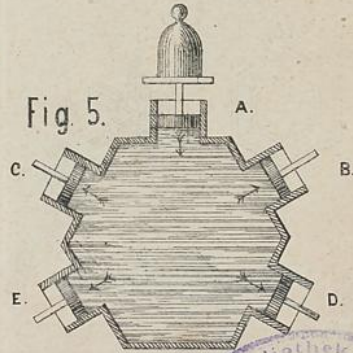

Fig. 7.

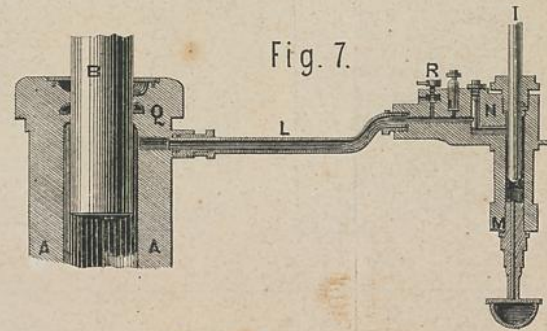

Fig. 8.

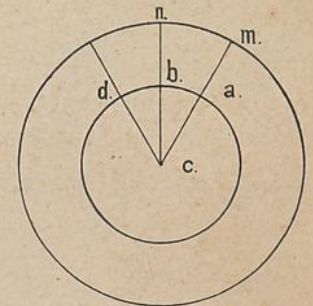

Fig. 8.

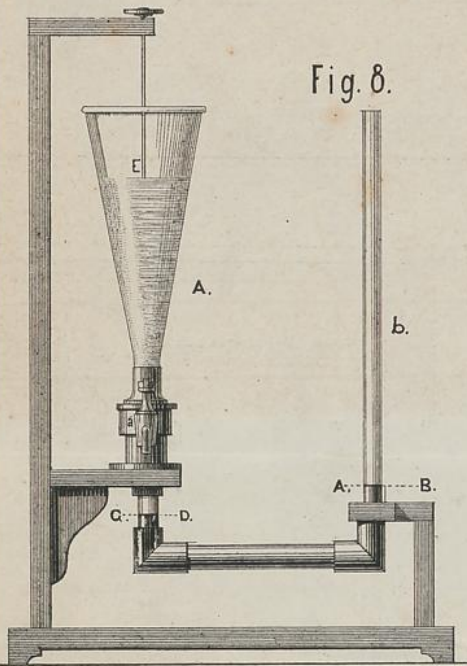

Fig. 9.

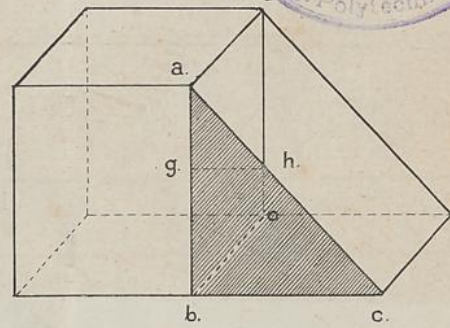

Fig. 12.

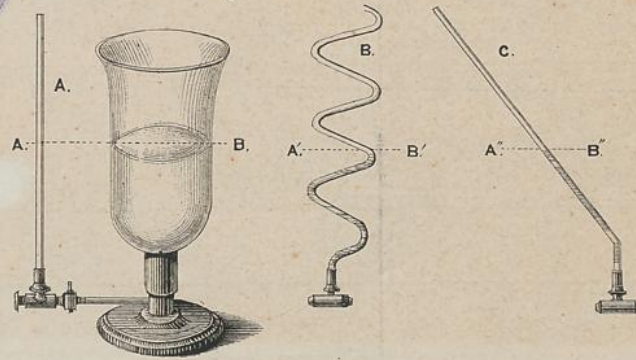

Fig. 15.

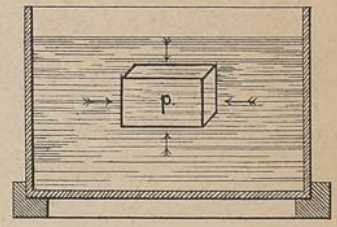

Fig. 10.

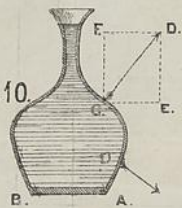

Fig. 11.

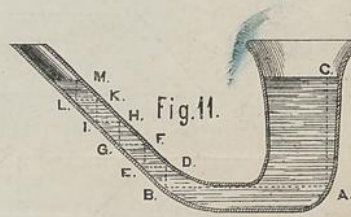

Fig. 13.

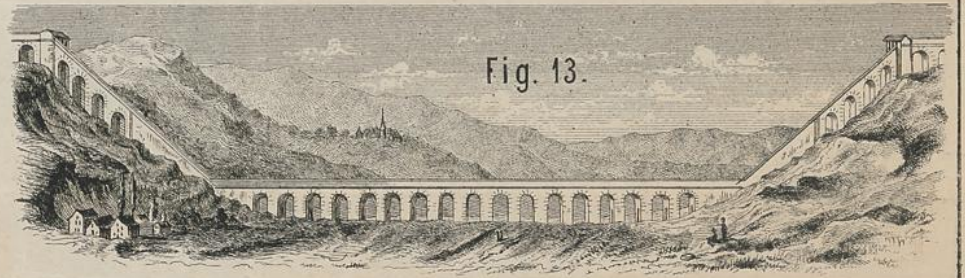

Fig. 14.

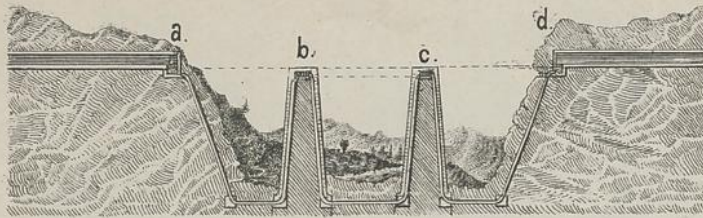

Fig. 16.

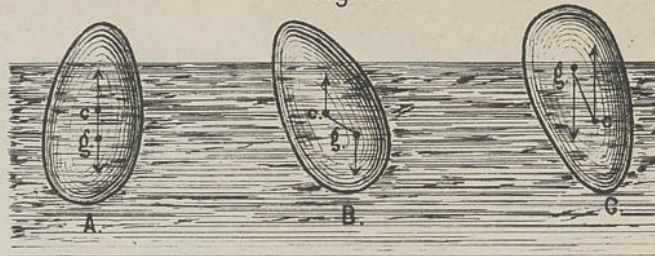

Fig. 17.

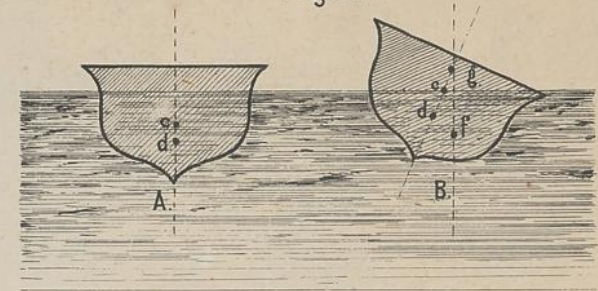

Fig. 19.

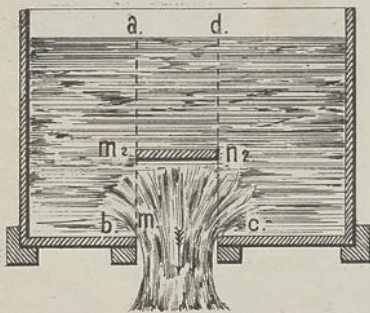

Fig. 21.

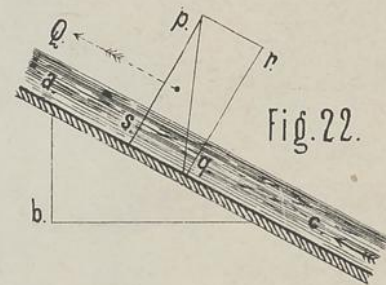
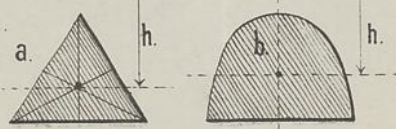

Fig. 22.

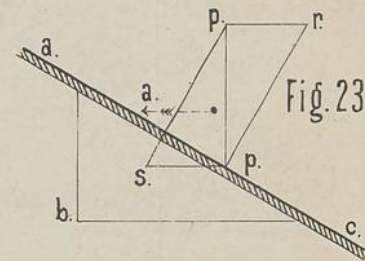

Fig. 23.

Fig. 18(a).

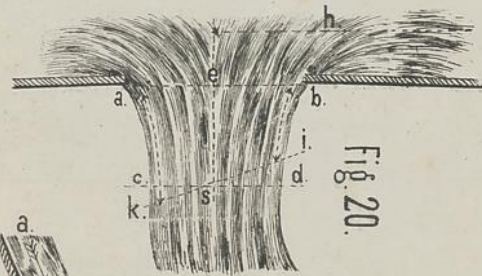

Fig. 20.

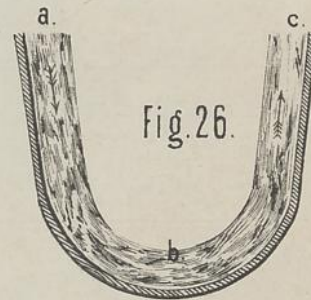

Fig. 26.

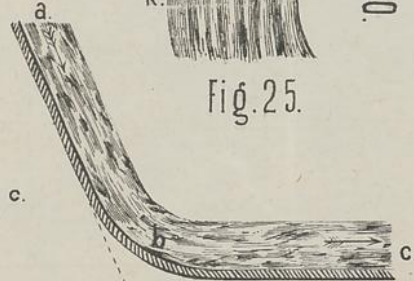

Fig. 25.

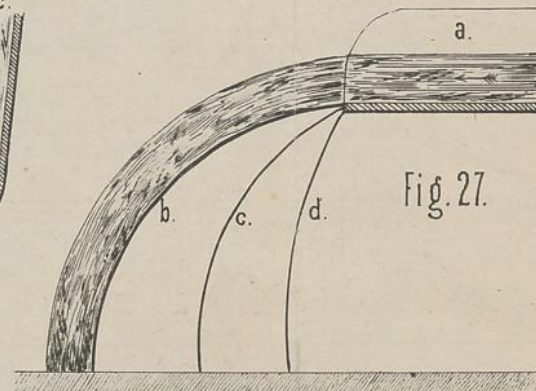

Fig. 27.

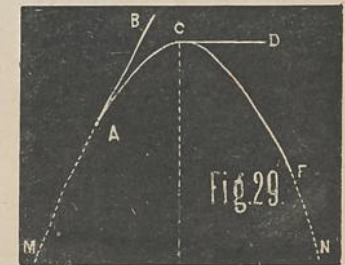

Fig. 29.

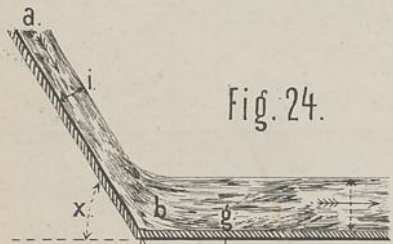

Fig. 24.

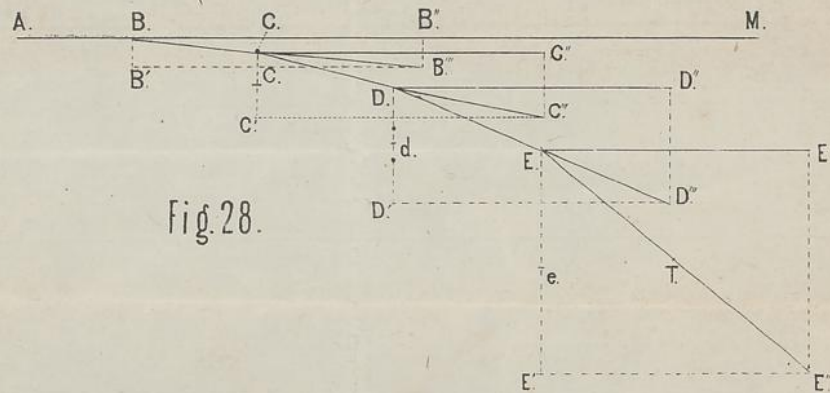

Fig. 28.

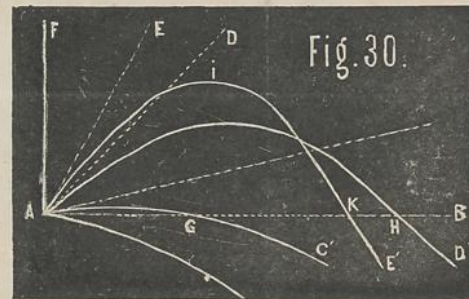

Fig. 30.

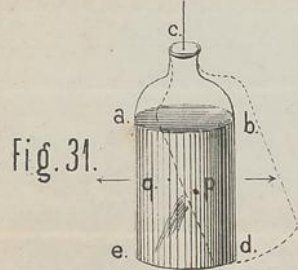

Fig. 31.

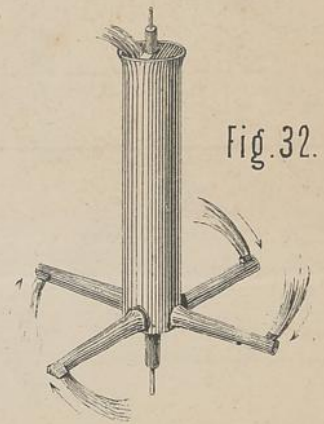

Fig. 32.

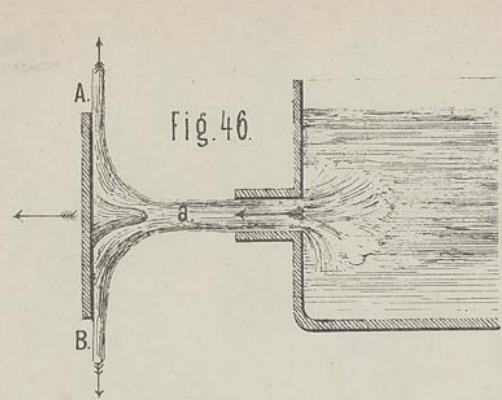

Fig. 46.

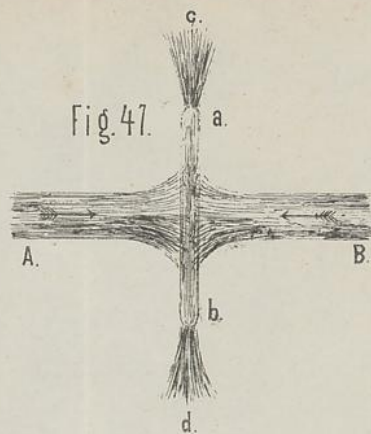

Fig. 47.

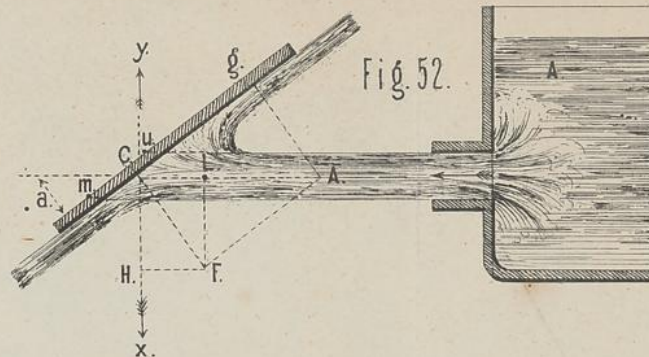

Fig. 52.

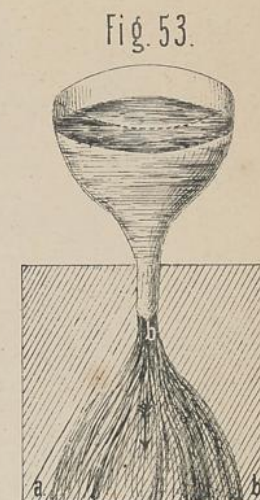

Fig. 53.

Fig. 48.

Fig. 51.

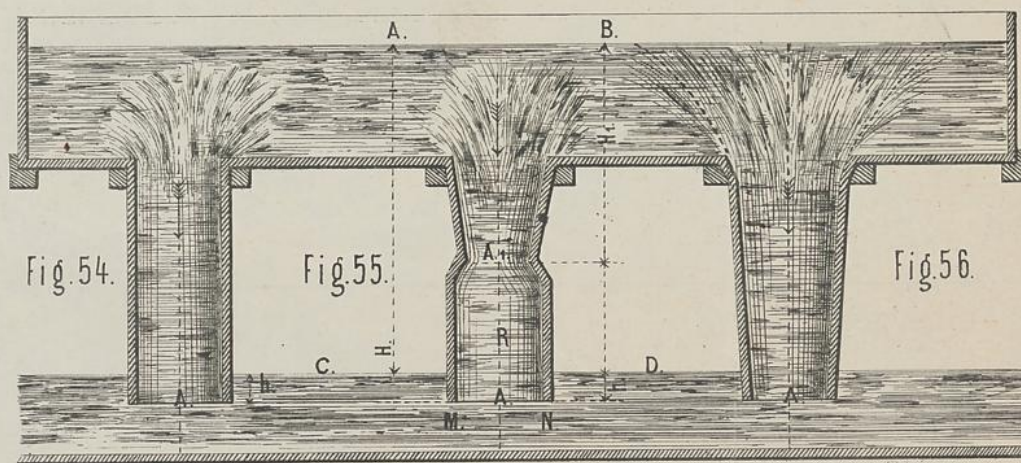
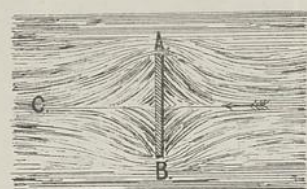
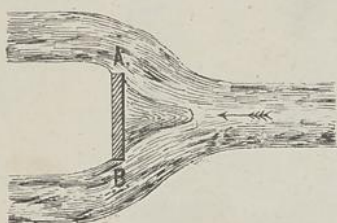

Fig. 54.

Fig. 55.

Fig. 56.

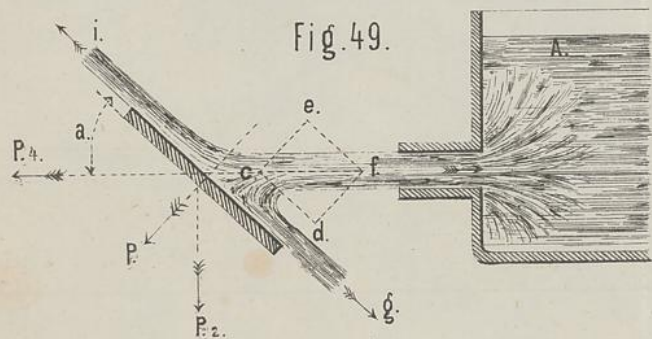

Fig. 49.

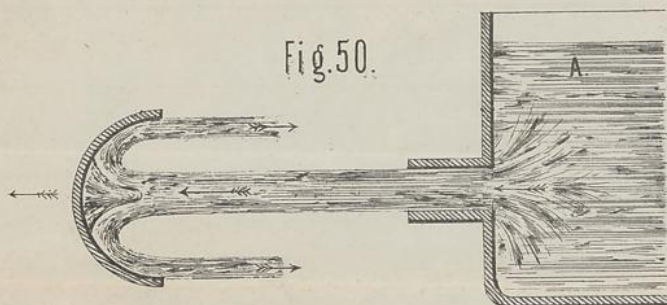

Fig. 50.

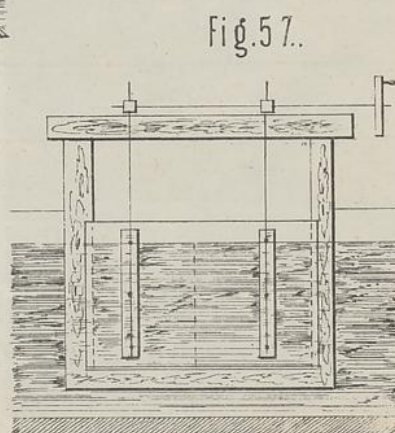

Fig. 57.

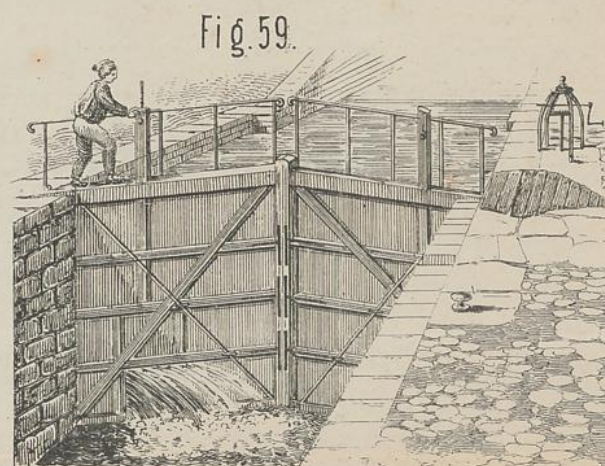

Fig. 59.

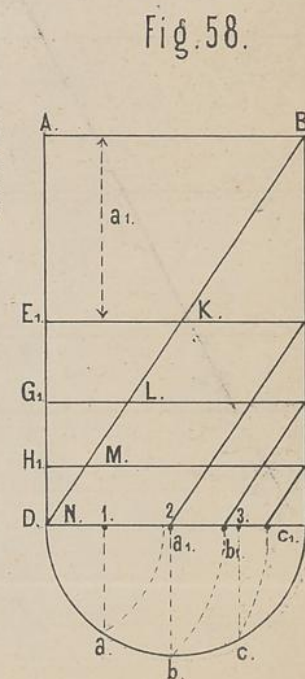

Fig. 58.

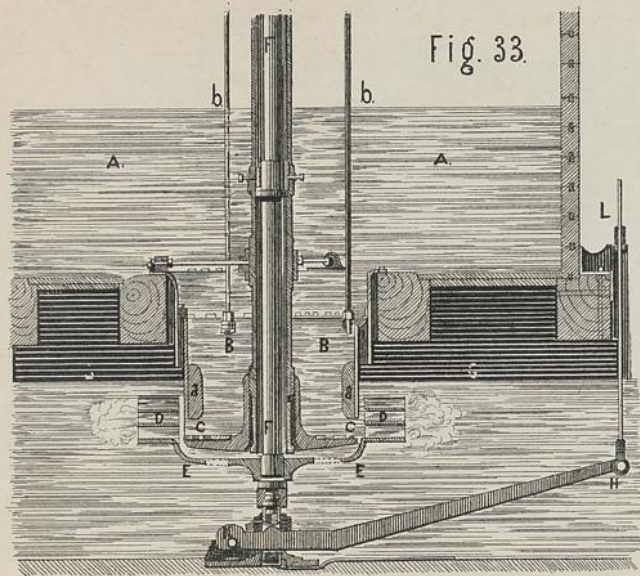

Fig. 33.

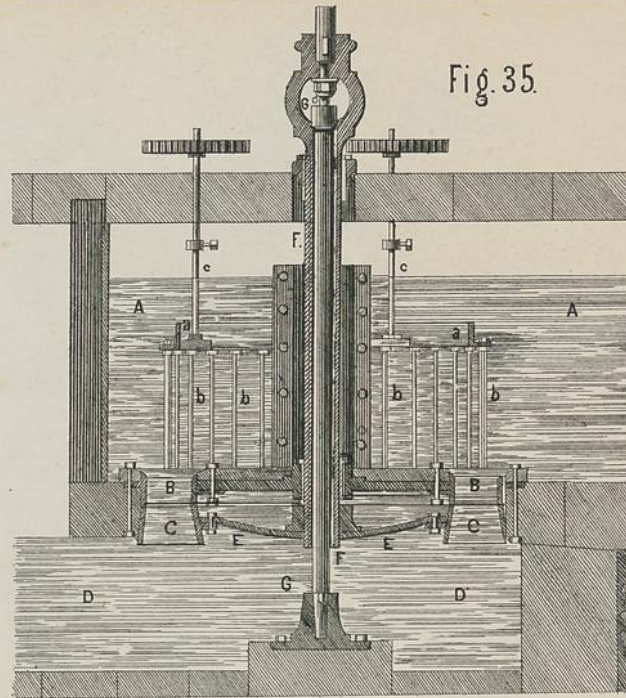

Fig. 35.

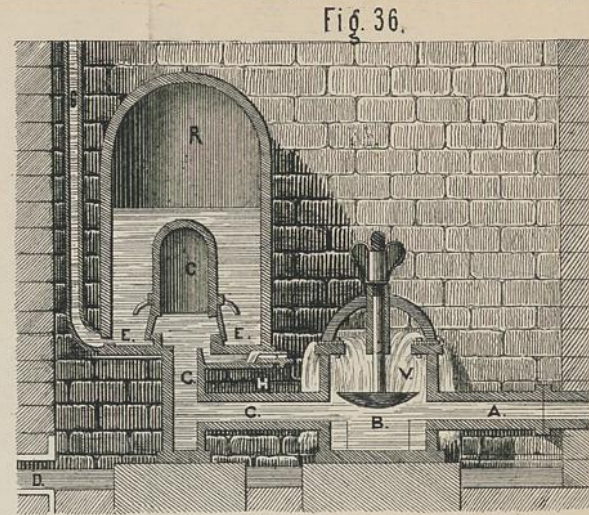

Fig. 36.

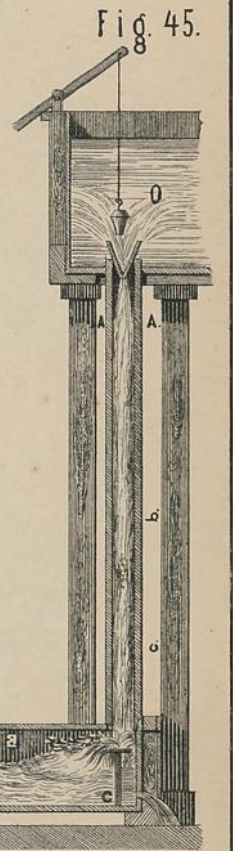

Fig. 45.

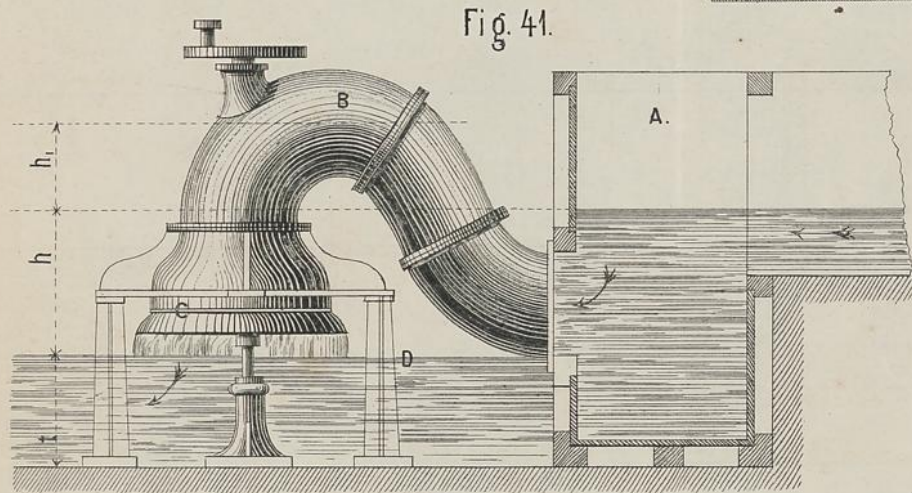

Fig. 41.

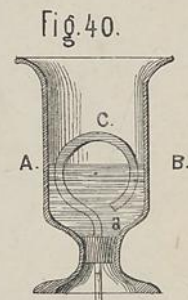

Fig. 40.

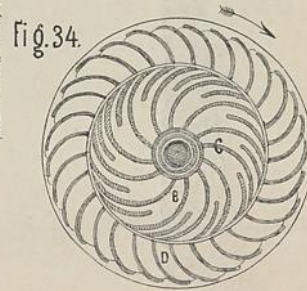

Fig. 34.

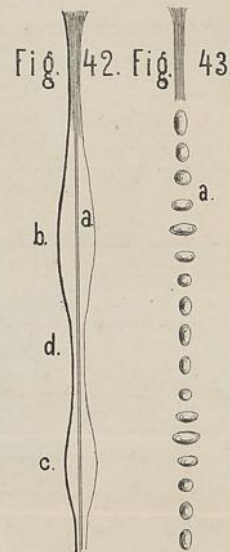

Fig. 42. Fig. 43.

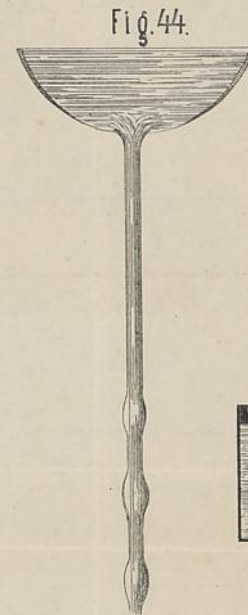

Fig. 44.

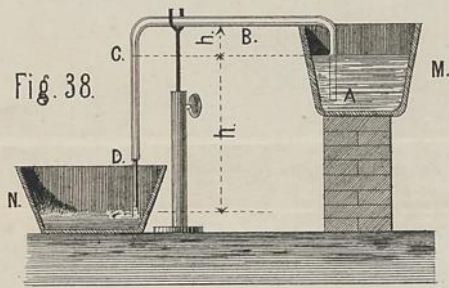

Fig. 38.

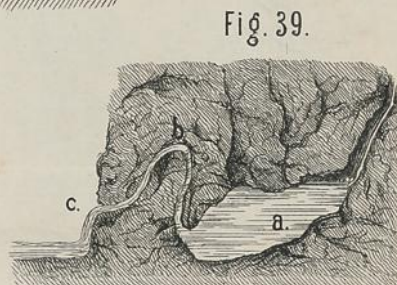

Fig. 39.

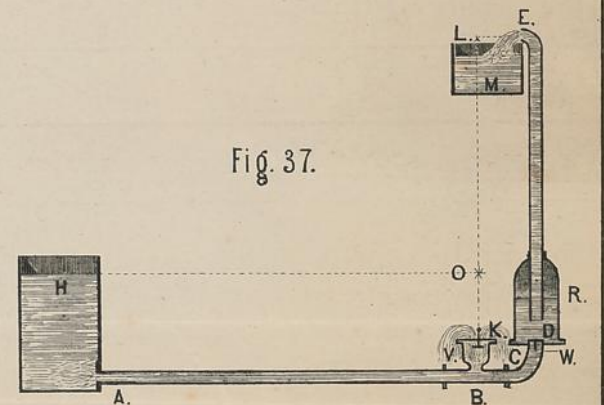

Fig. 37.

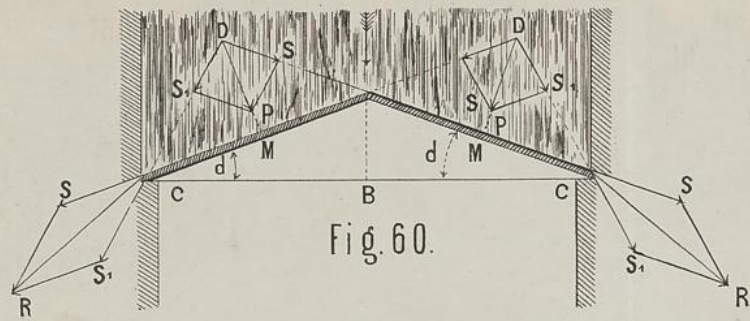

Fig. 60.

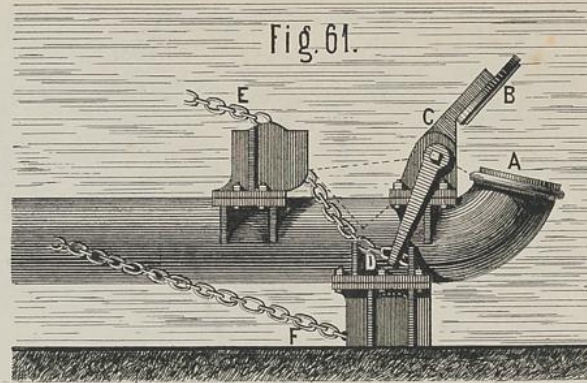

Fig. 61.

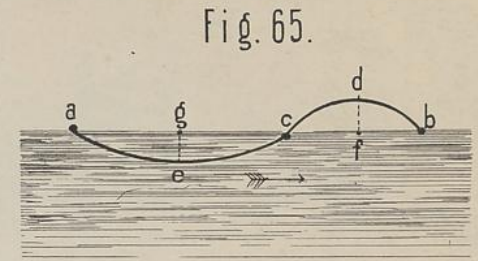

Fig. 65.

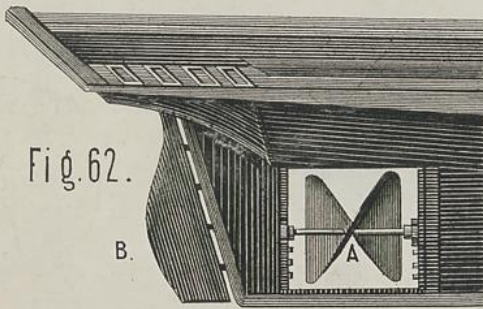

Fig. 62.

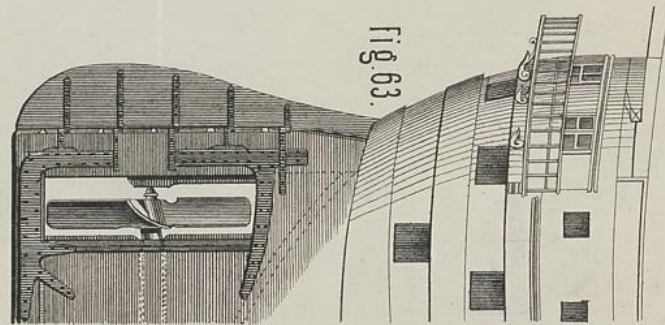

Fig. 63.

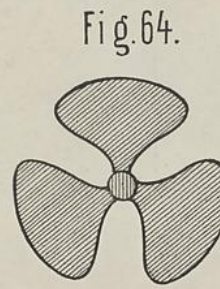

Fig. 64.

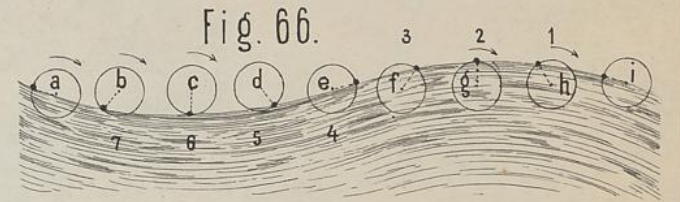

Fig. 66.

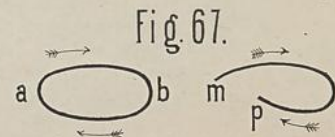

Fig. 67.

Fig. 69.

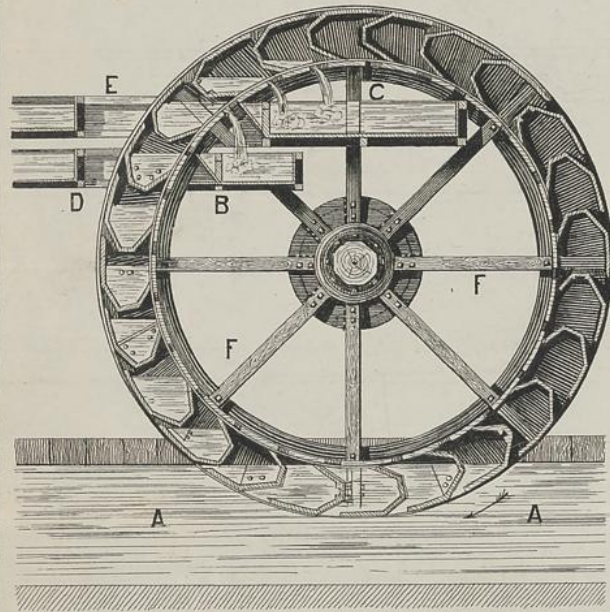

Fig. 70.

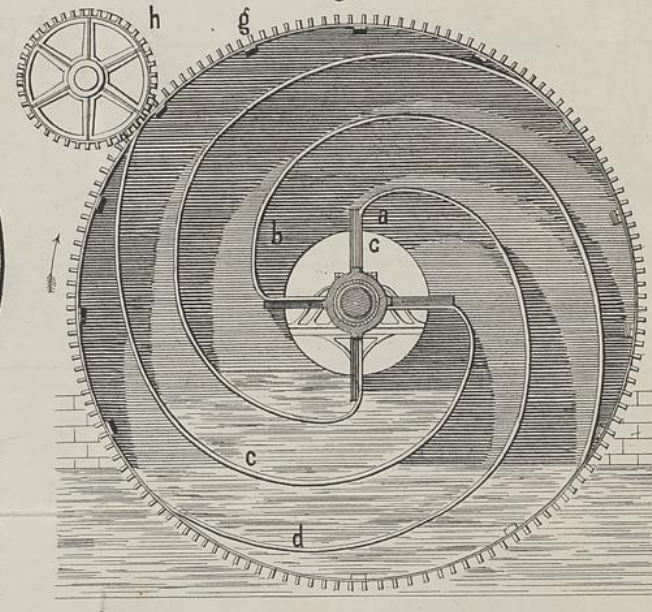

Fig. 73.

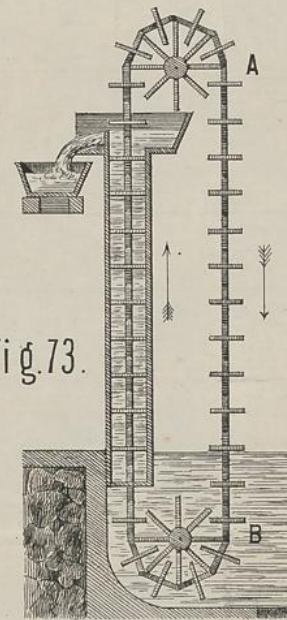

Fig. 68.

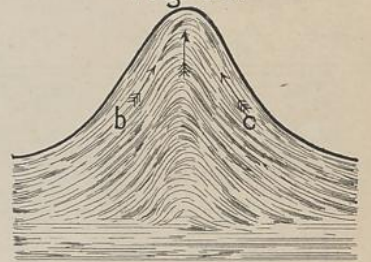

Fig. 74.

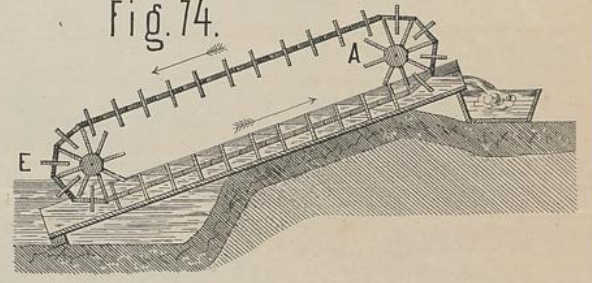

Fig.71.

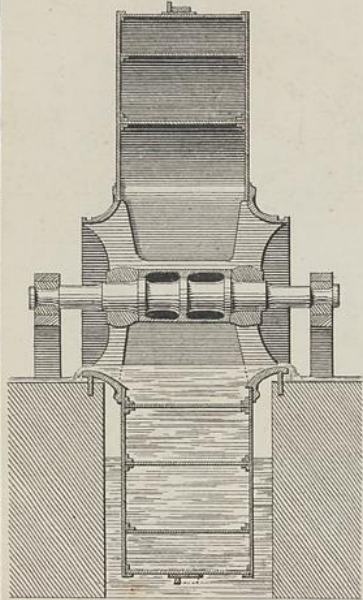

Fig.75.

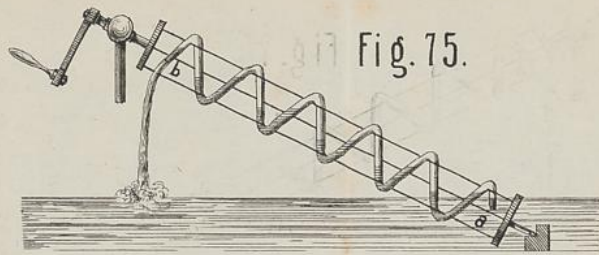

Fig.76.

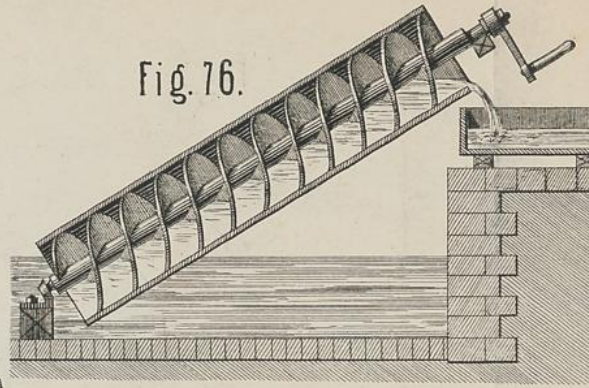

Fig.78.

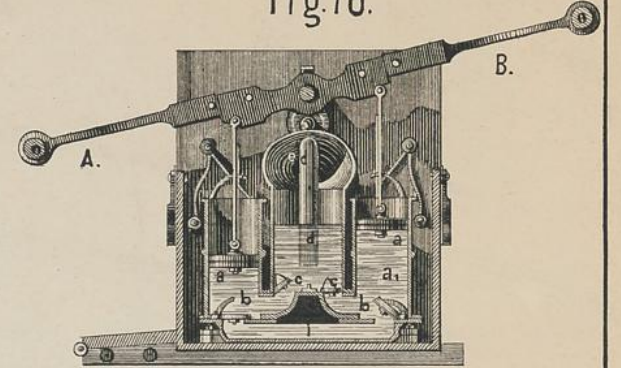

Fig. 72.



Fig.79.

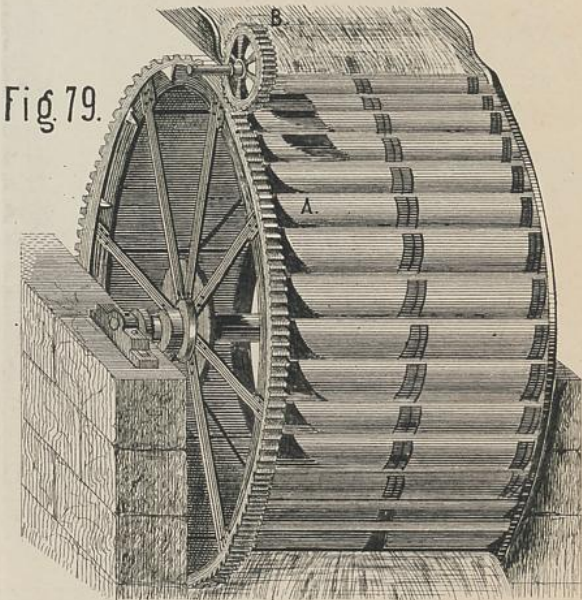

Fig.77.

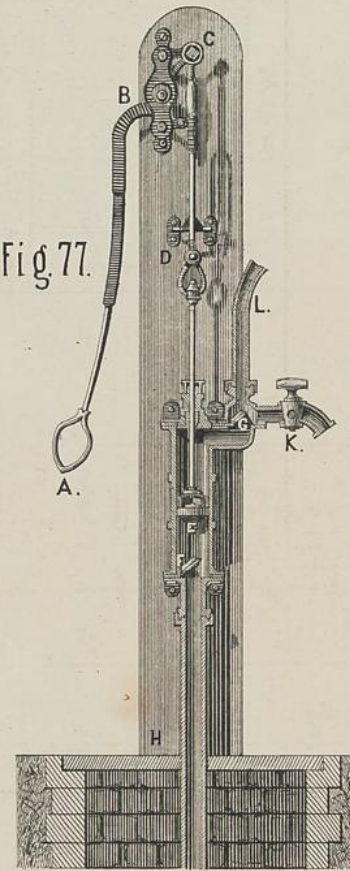

Fig.80.

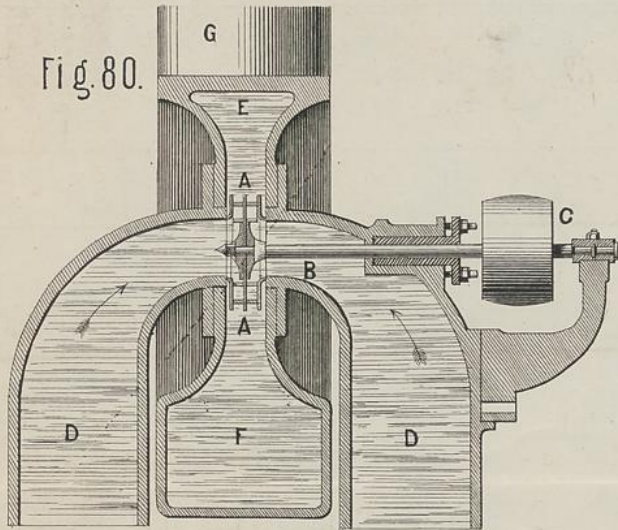

Fig.82.

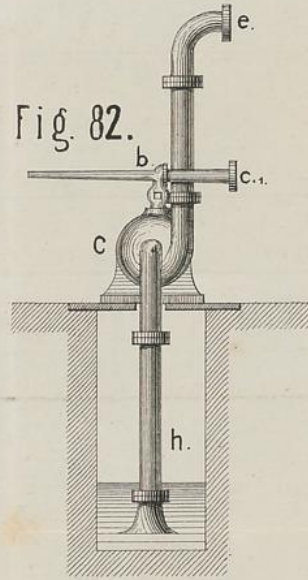
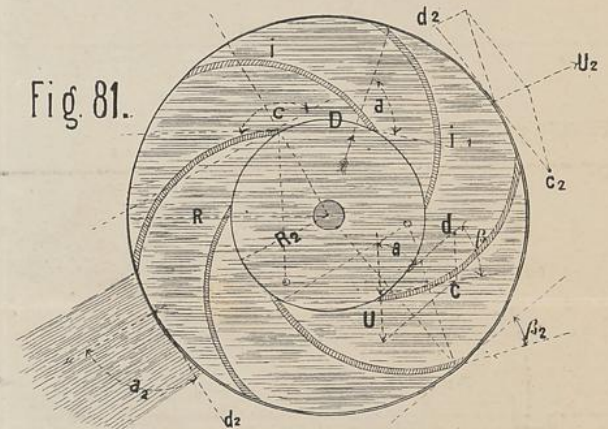

Fig.81.



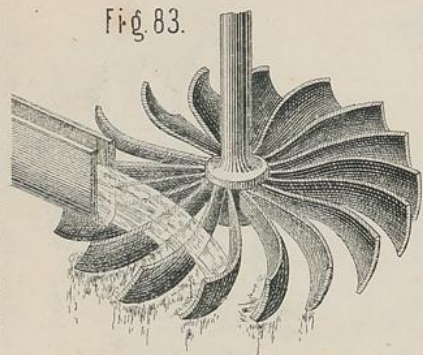

Fig. 83.

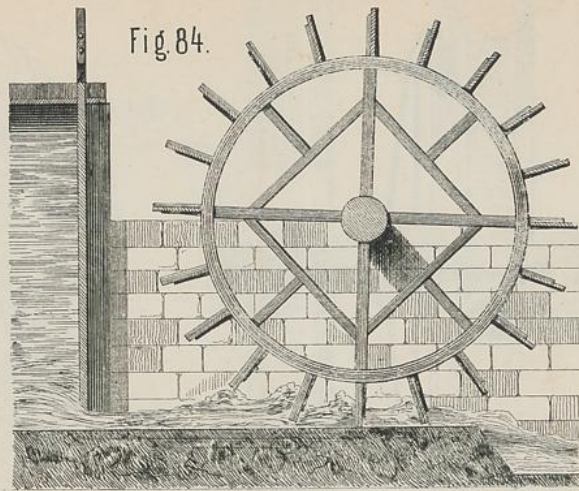

Fig. 84.

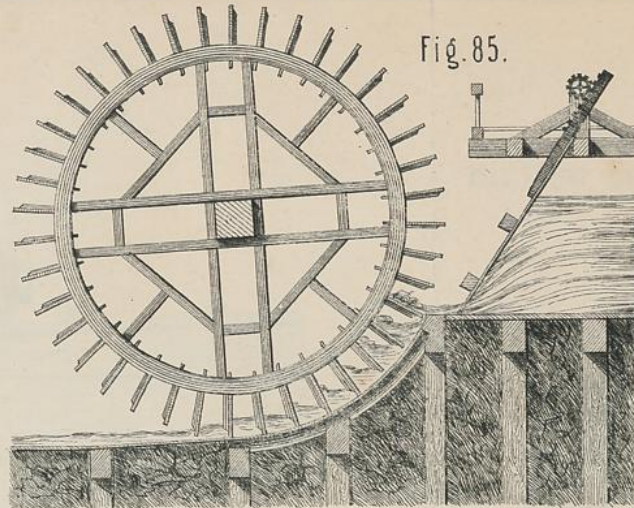

Fig. 85.

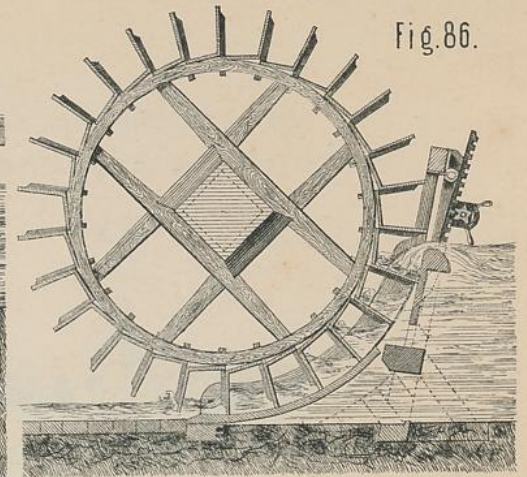

Fig. 86.

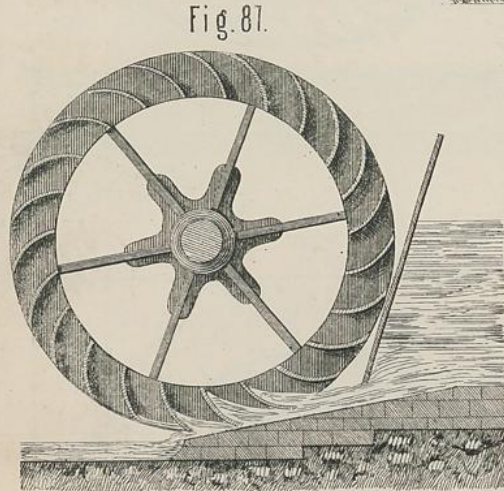

Fig. 87.

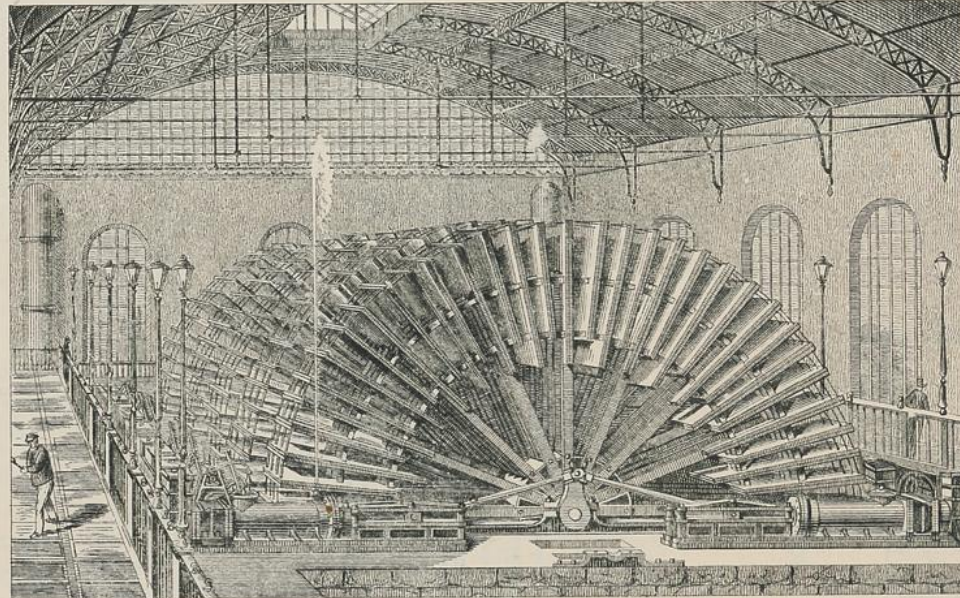

Fig. 88.

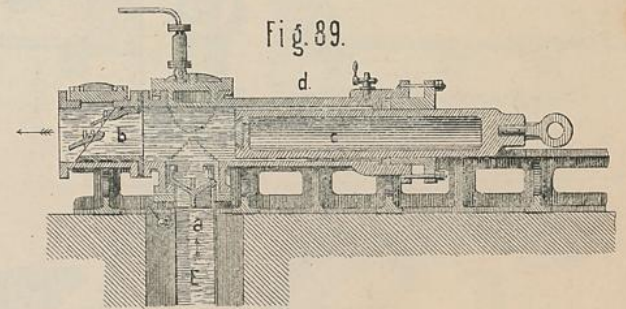

Fig. 89.

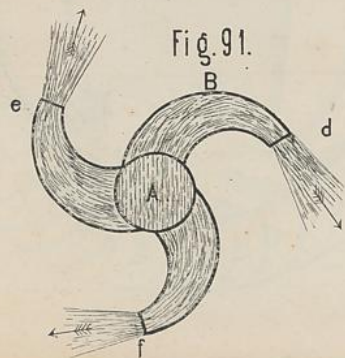

Fig. 91.

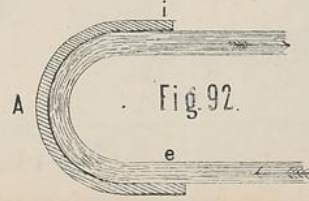

Fig. 92.

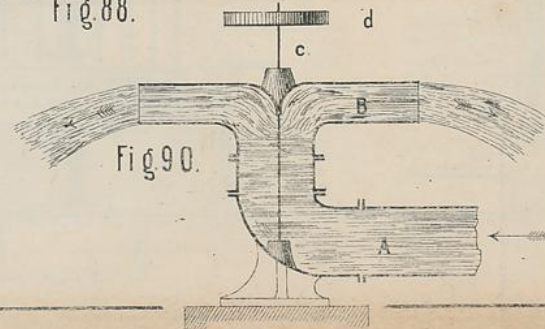

Fig. 90.

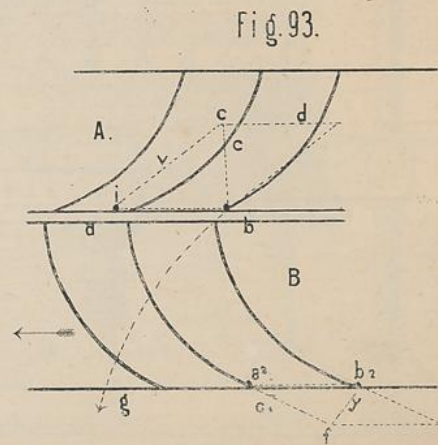
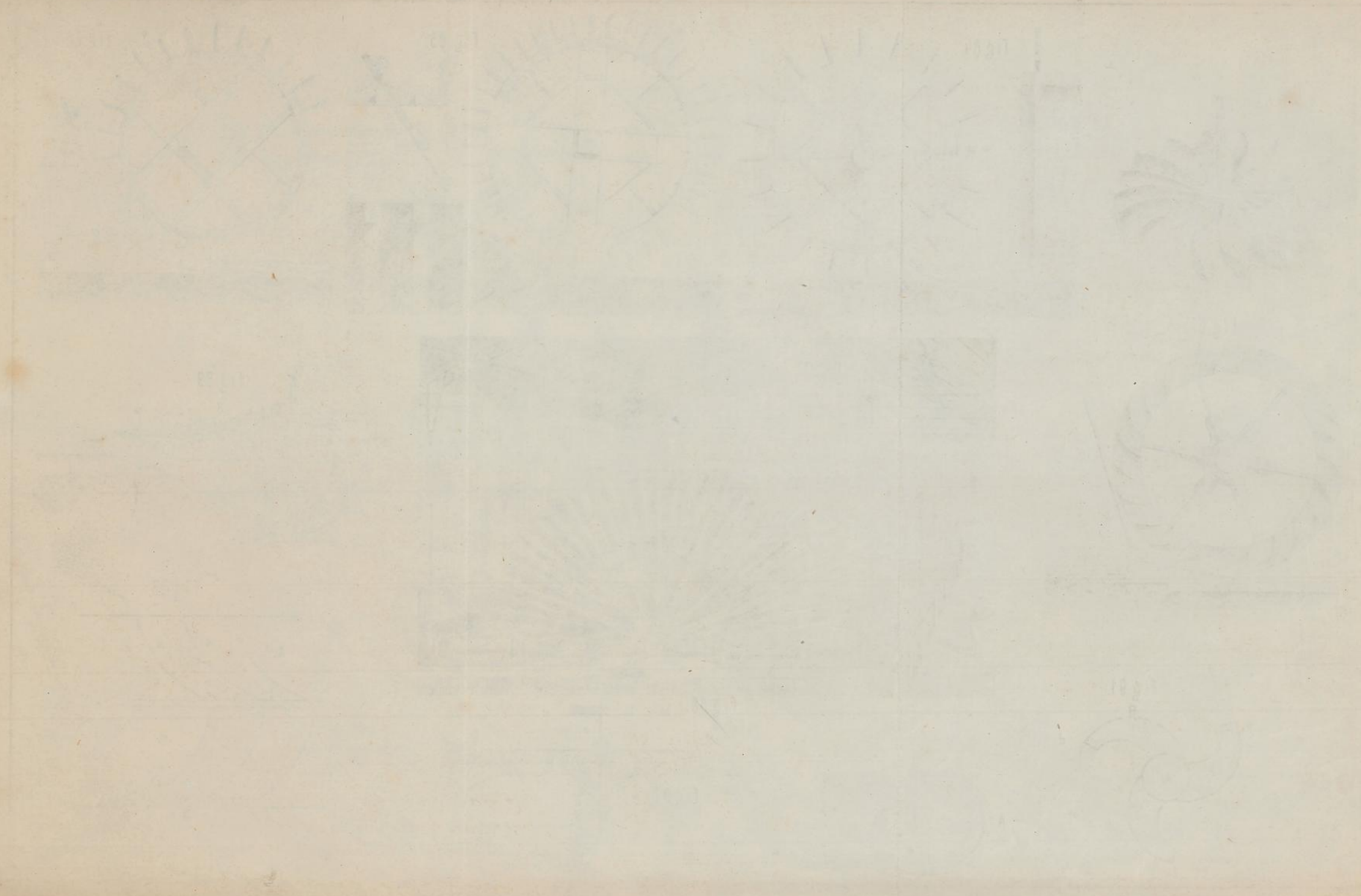

Fig. 93.

Hydrograph



Turbinen nach Girard's System,
mit freier Abweichung u. mit Ventilation.

Fig. 95 f.

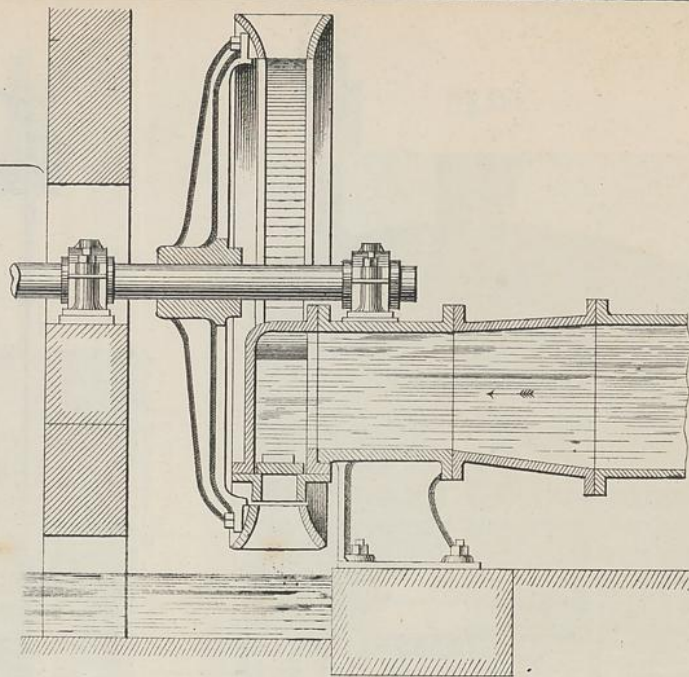
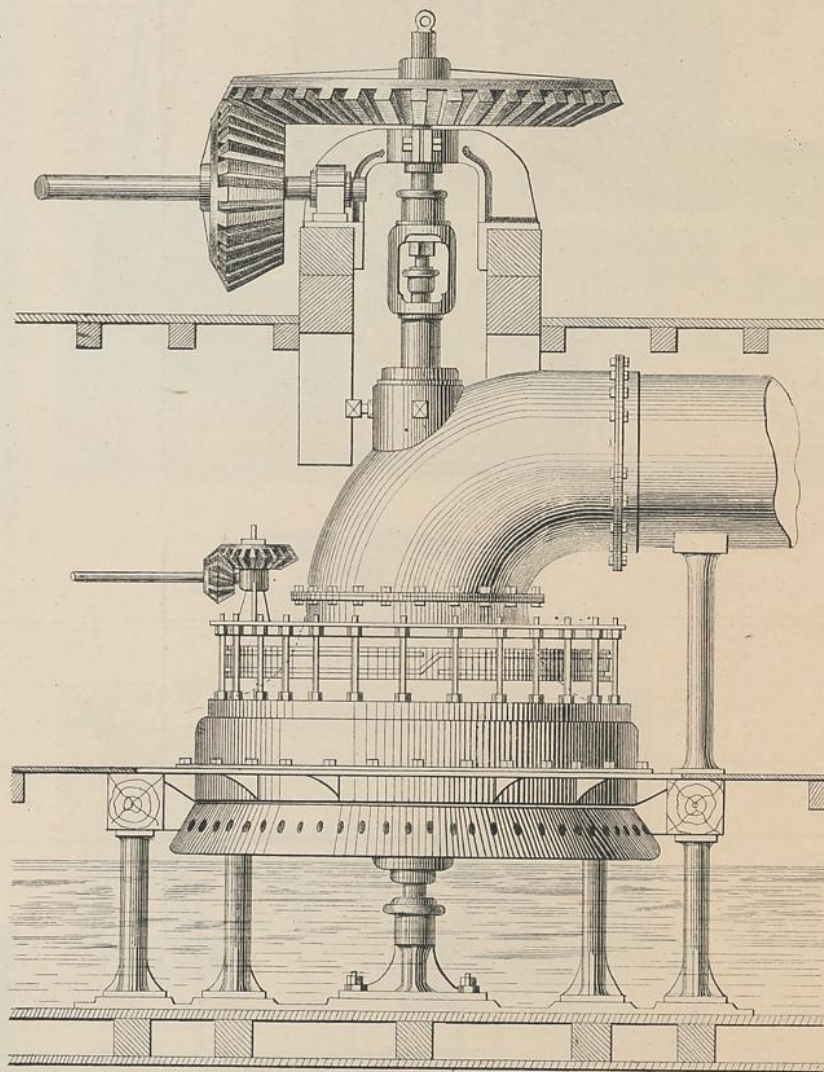

Fig. 95 c.

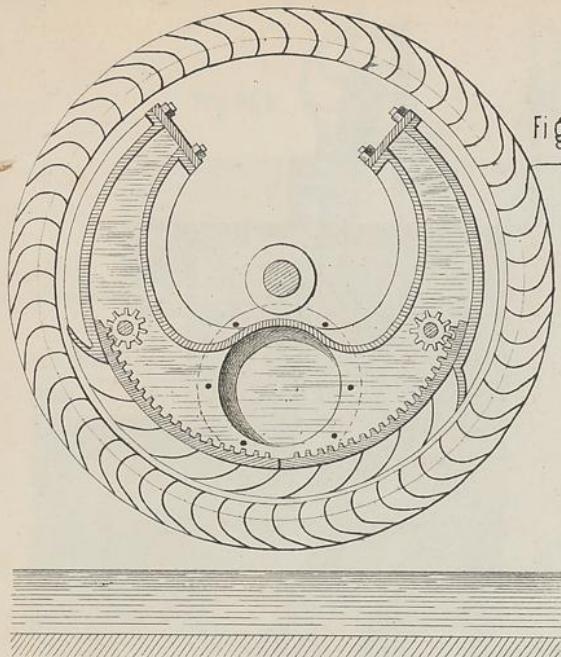

Fig. 95 d.

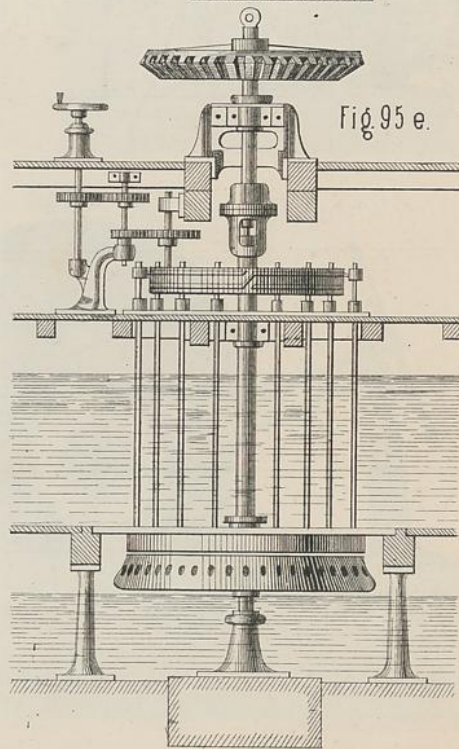

Fig. 95 e.

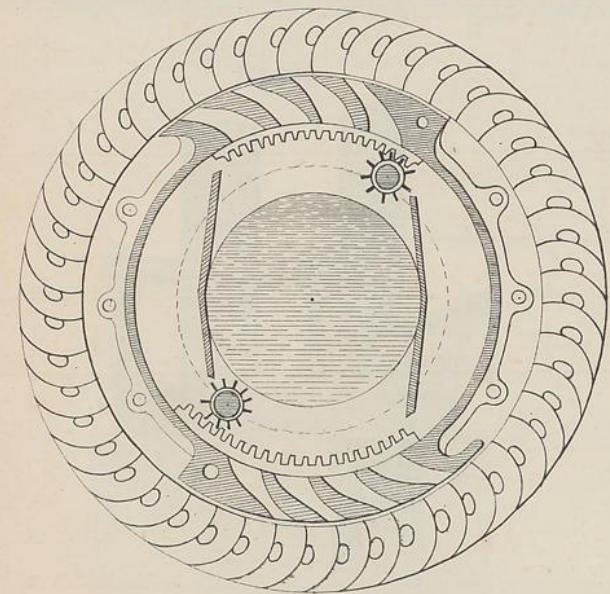

Fig. 1. Hydraulic Press

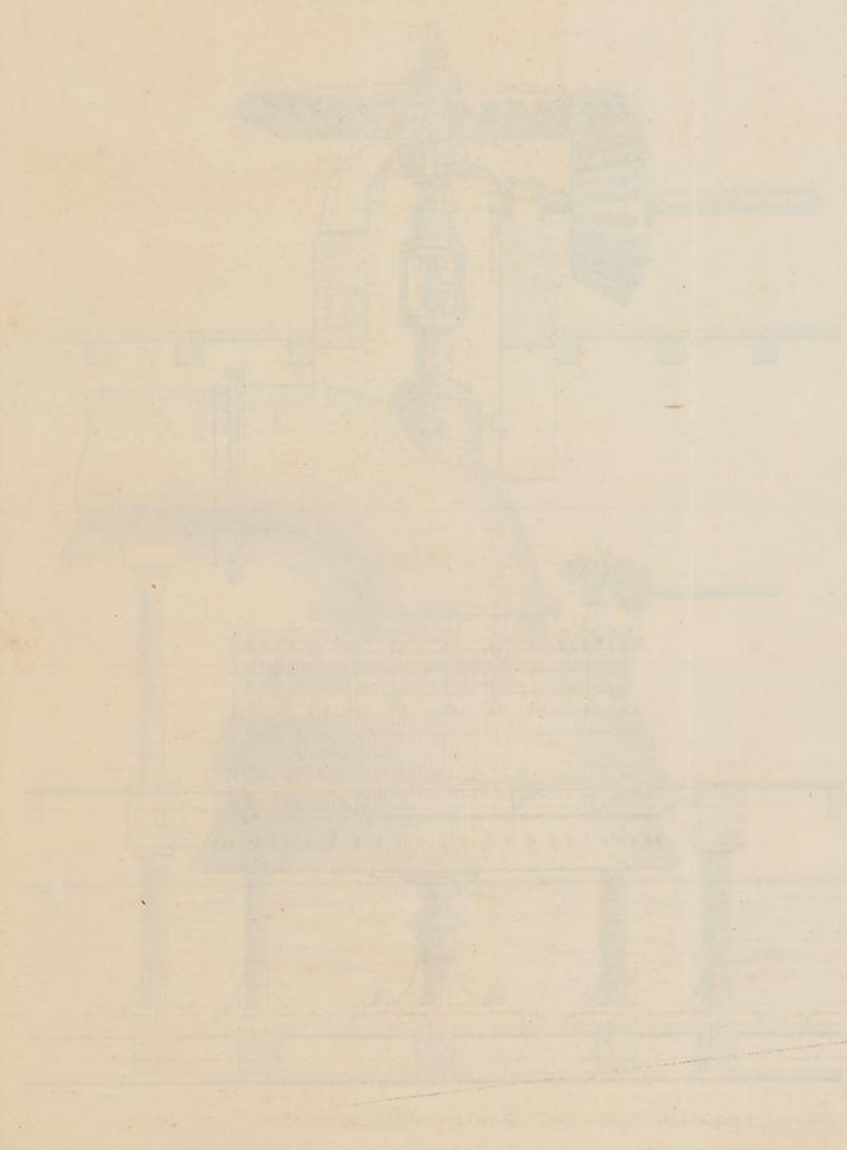

Fig. 2. Hydraulic Press

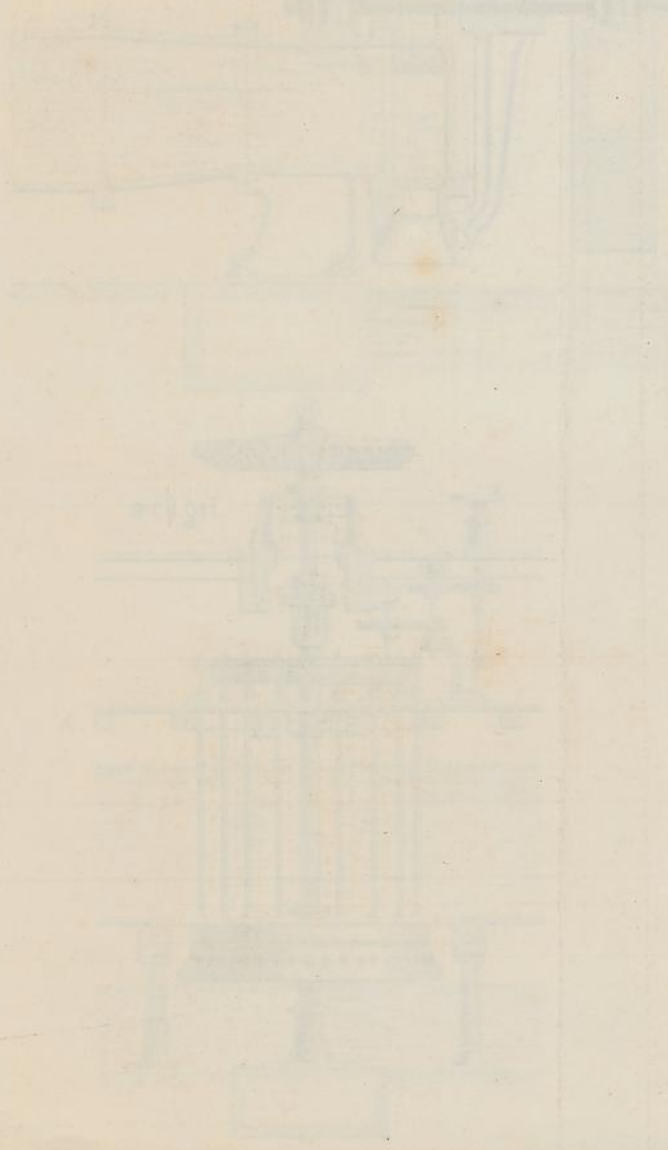

Fig. 3



Fig. 4



Fig. 95.h.

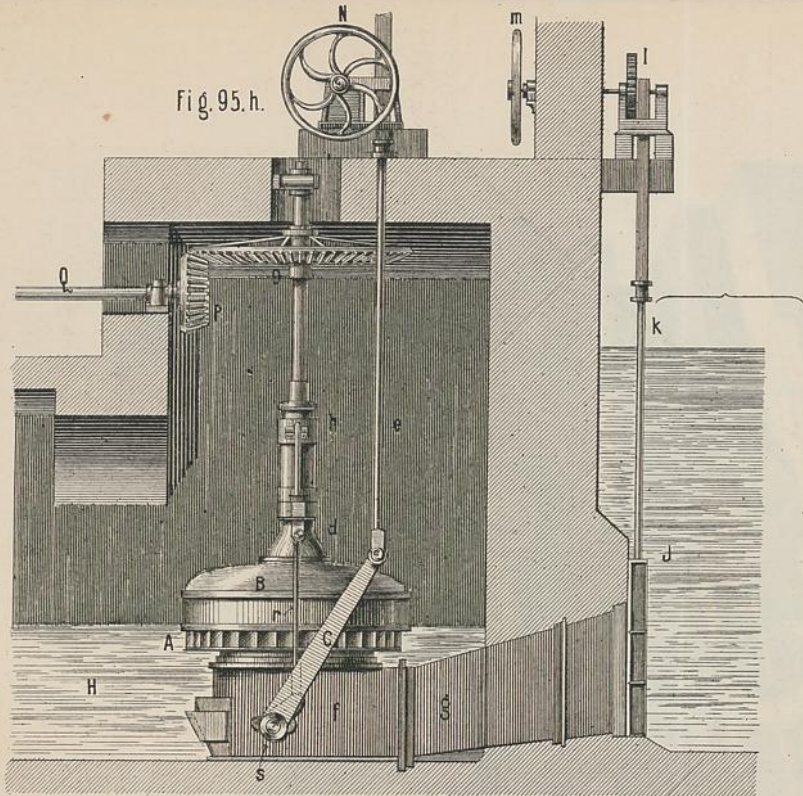

Fig. 95.i.

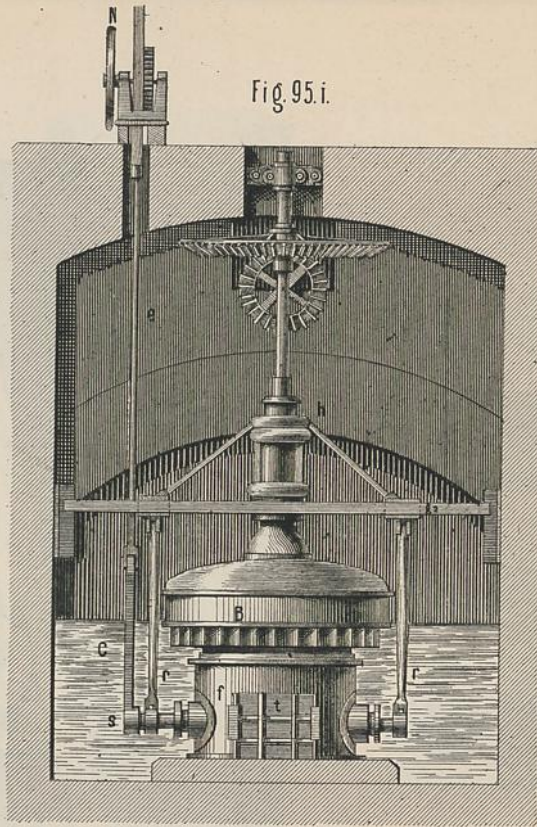

Fig. 95.k.

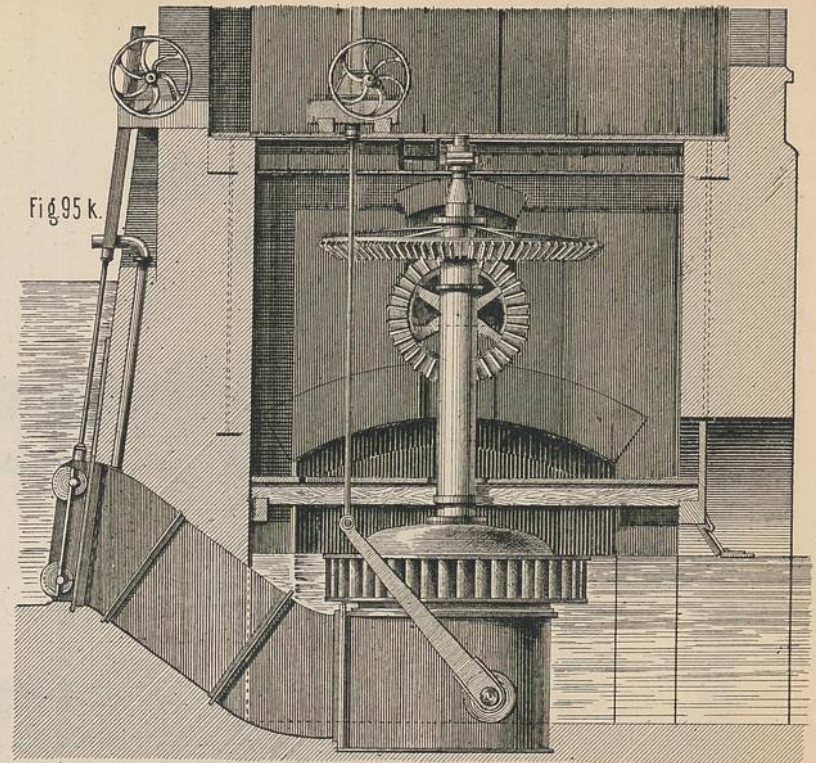

Fig. 95.l.

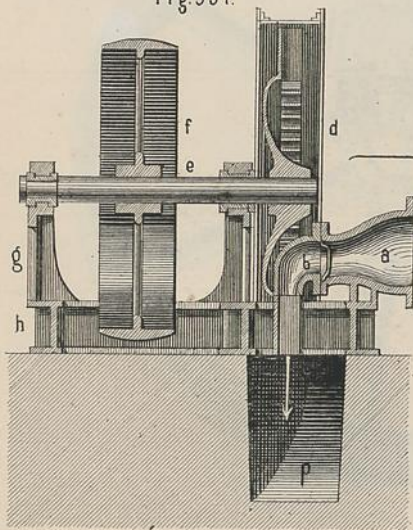

Fig. 95.m.

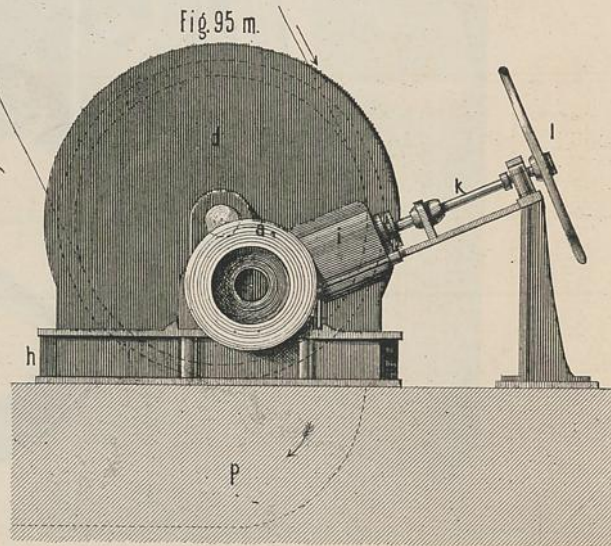
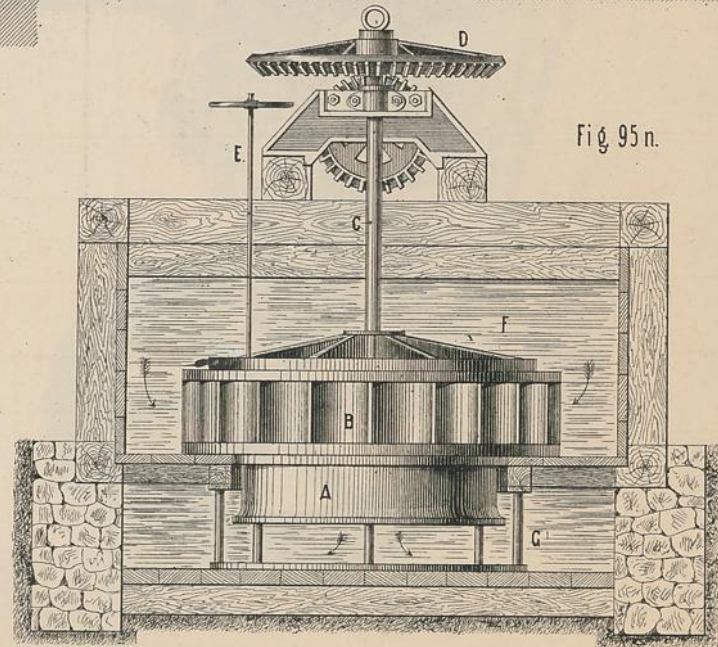
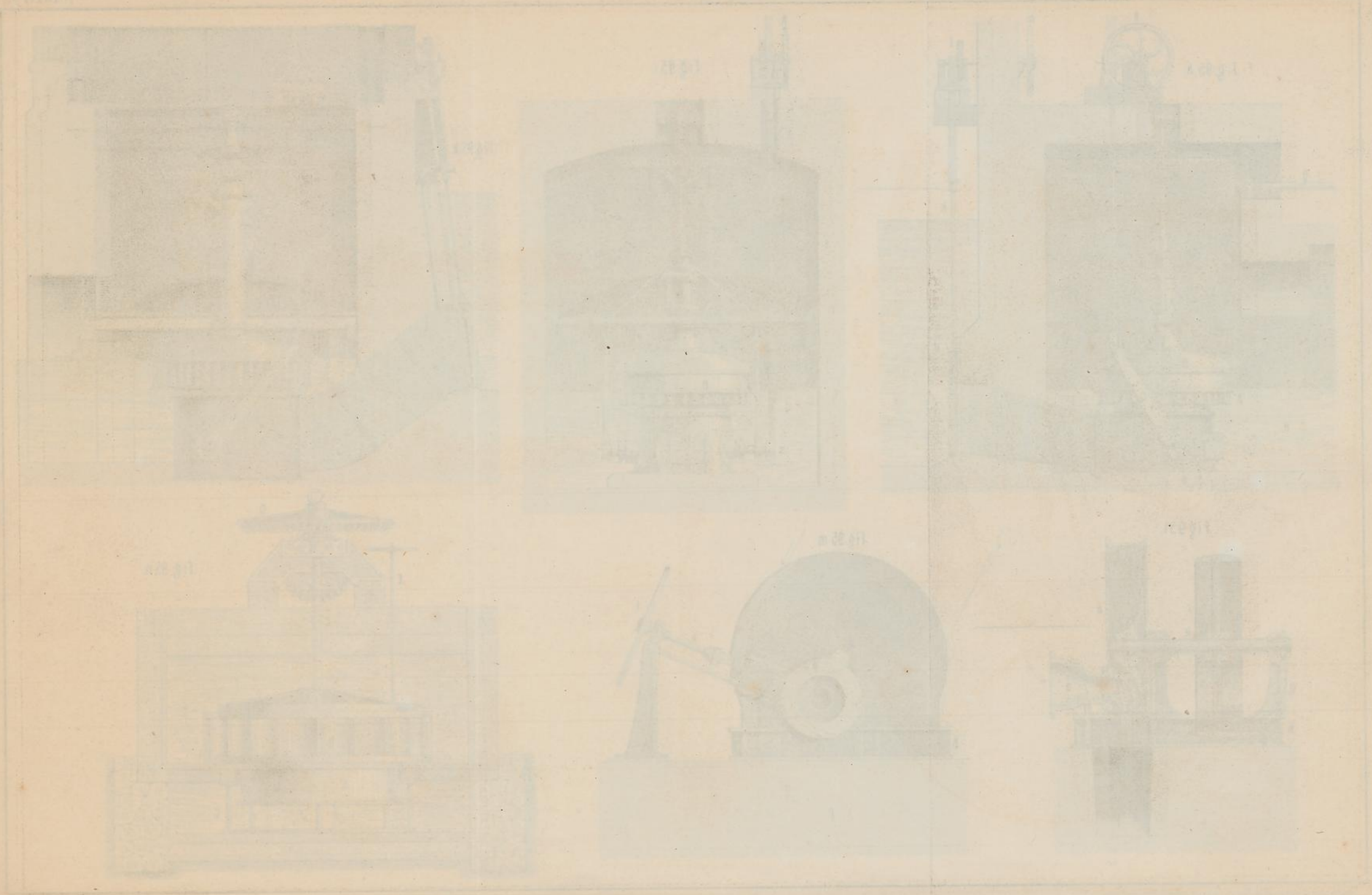

Fig. 95.n.





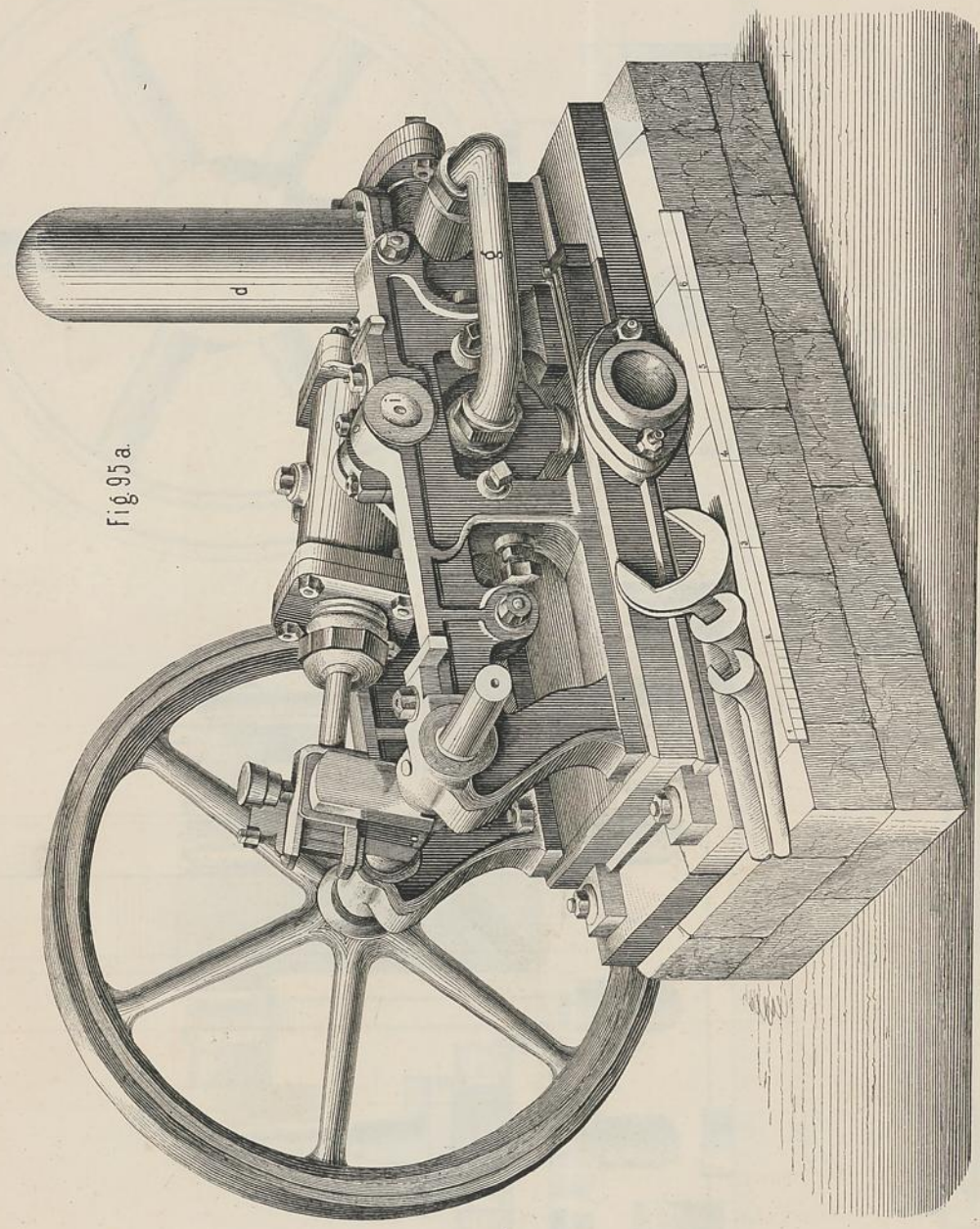

Fig. 95 a.

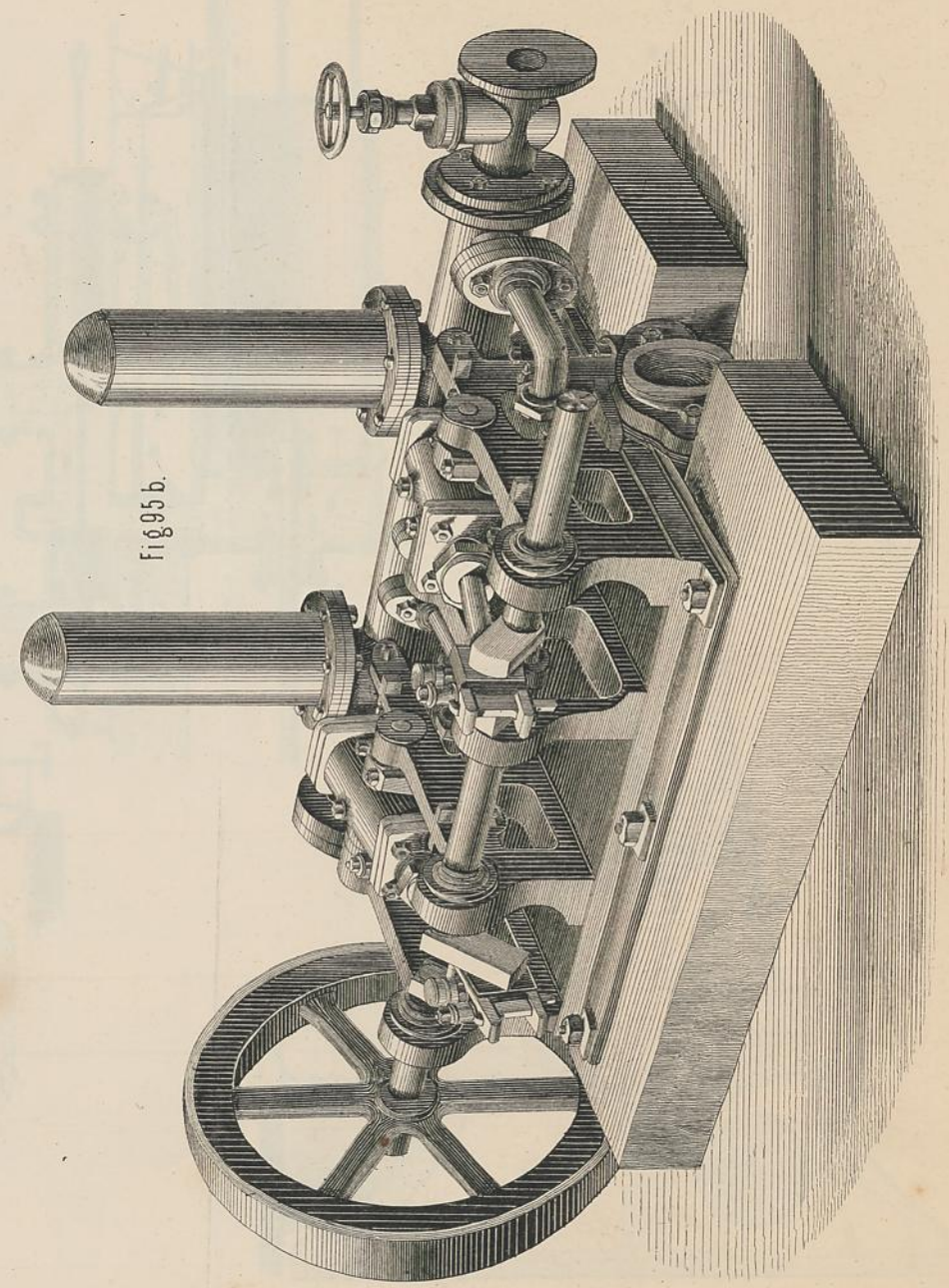
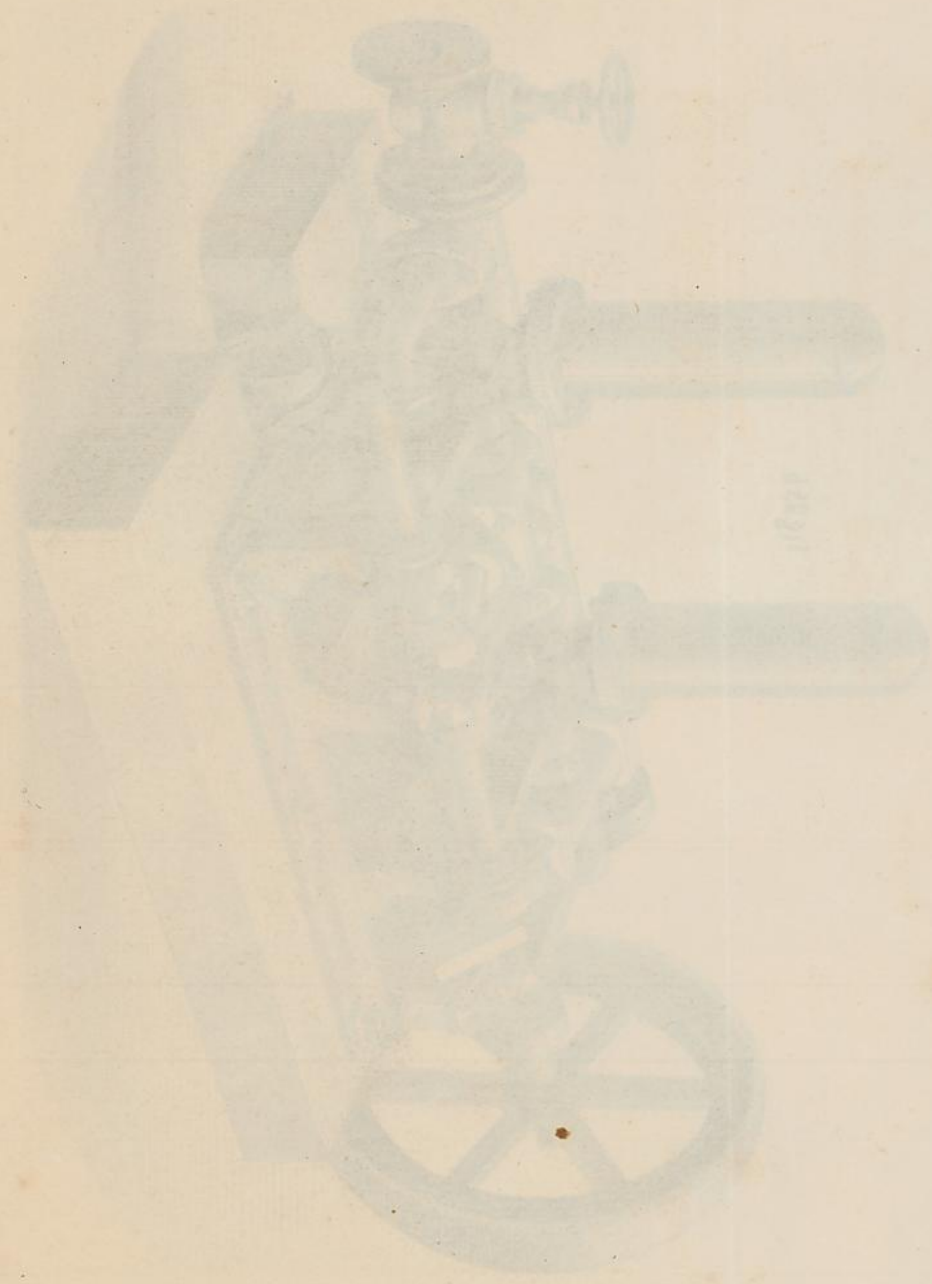

Fig. 95 b.



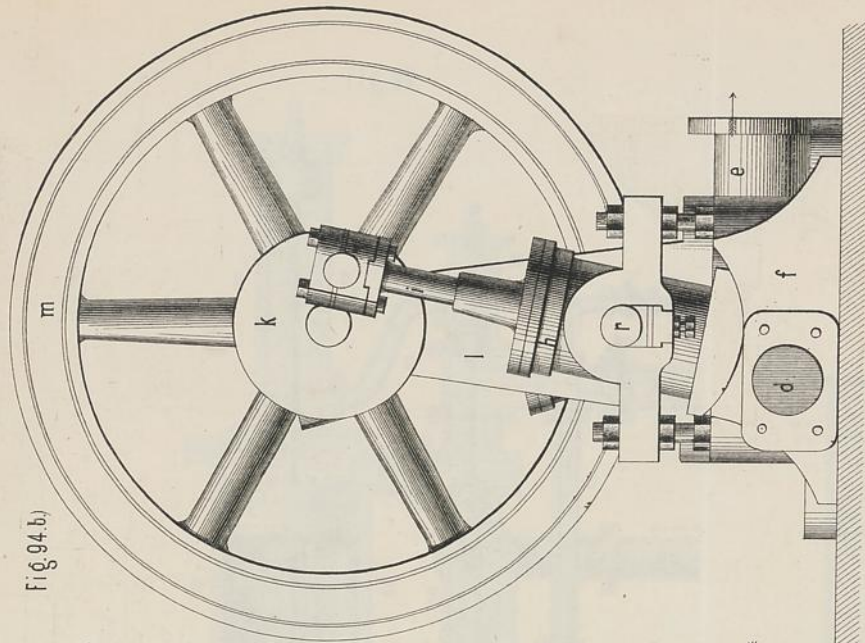

Fig. 94.b)

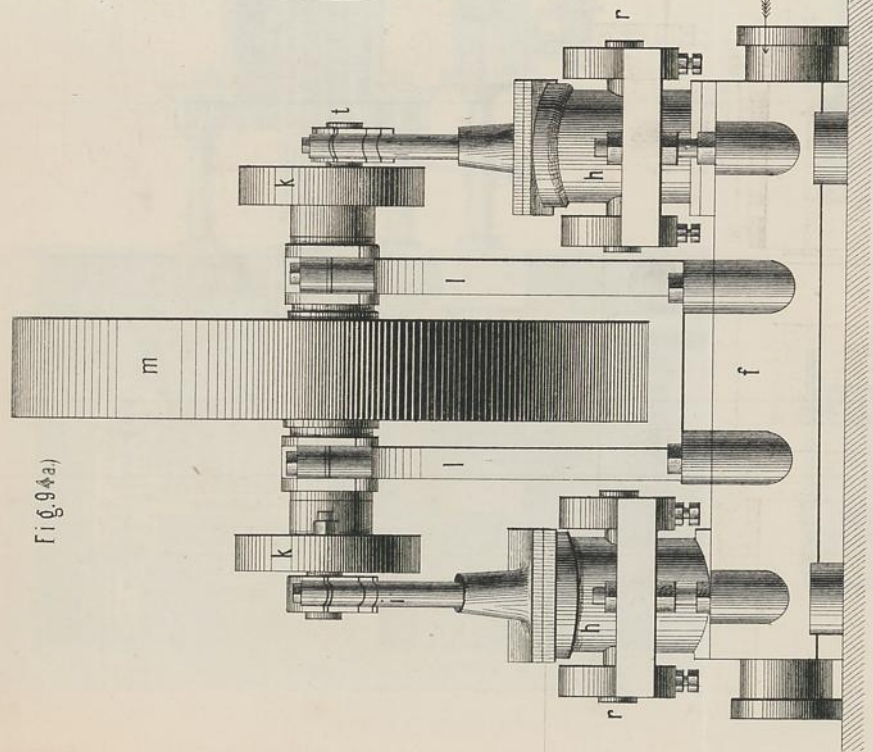

Fig. 94.a)

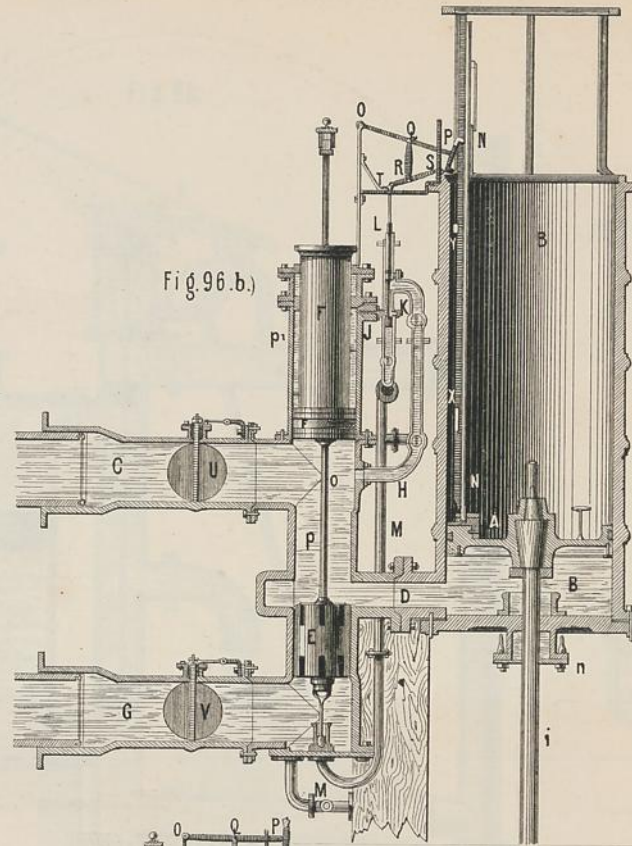

Fig. 96.b)

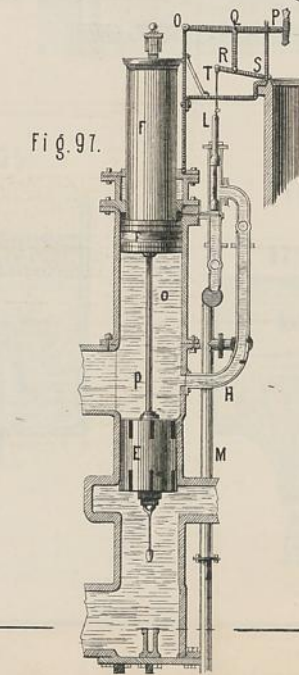

Fig. 97.

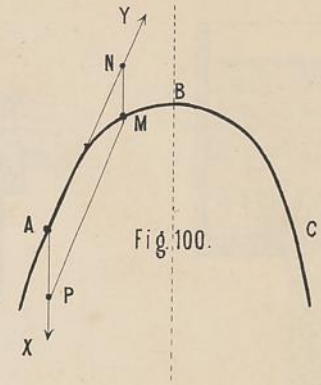

Fig. 100.

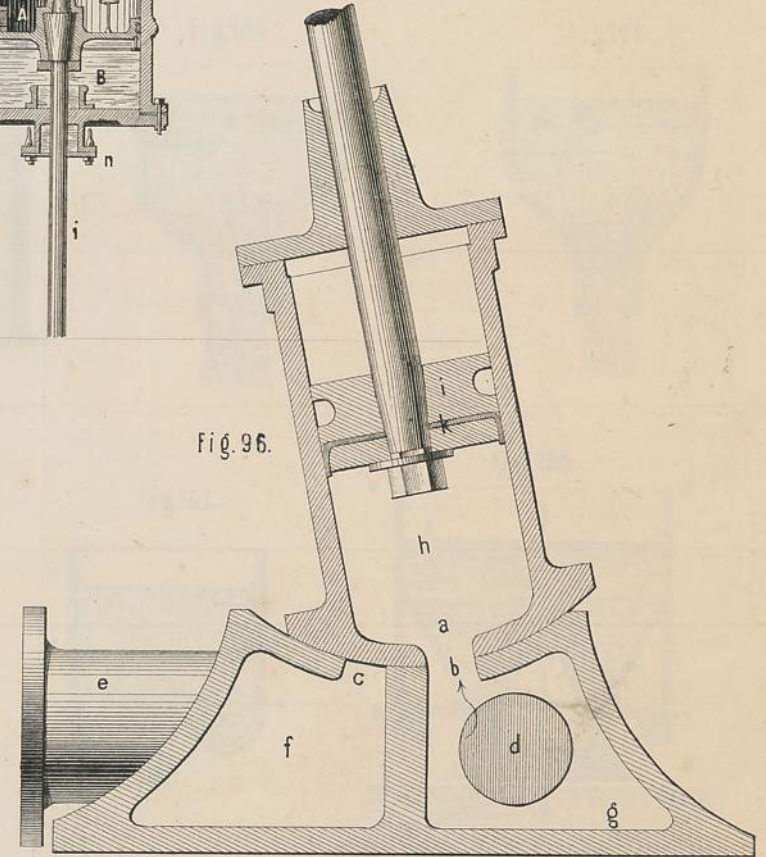

Fig. 96.

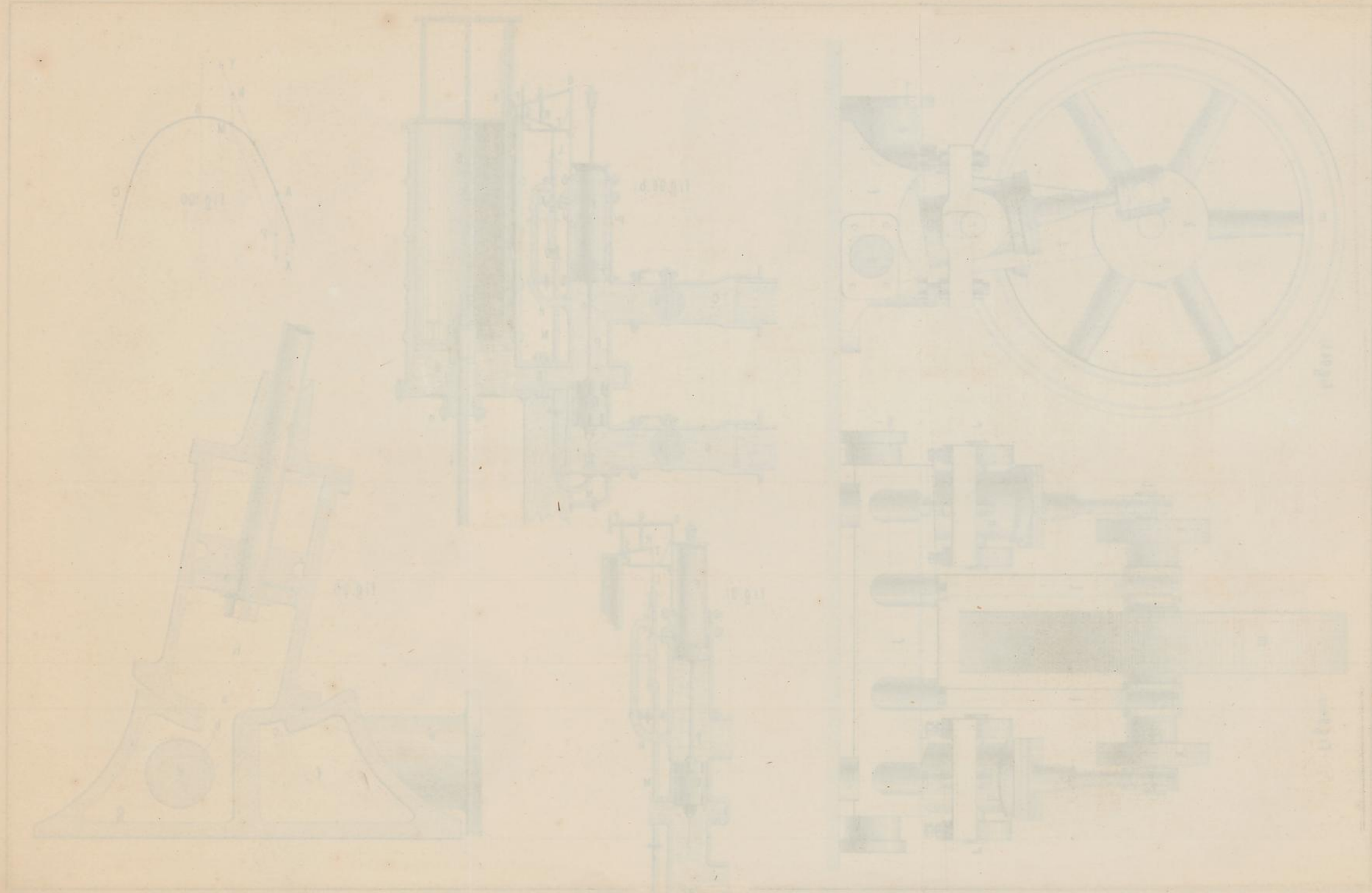

Fig. 99.

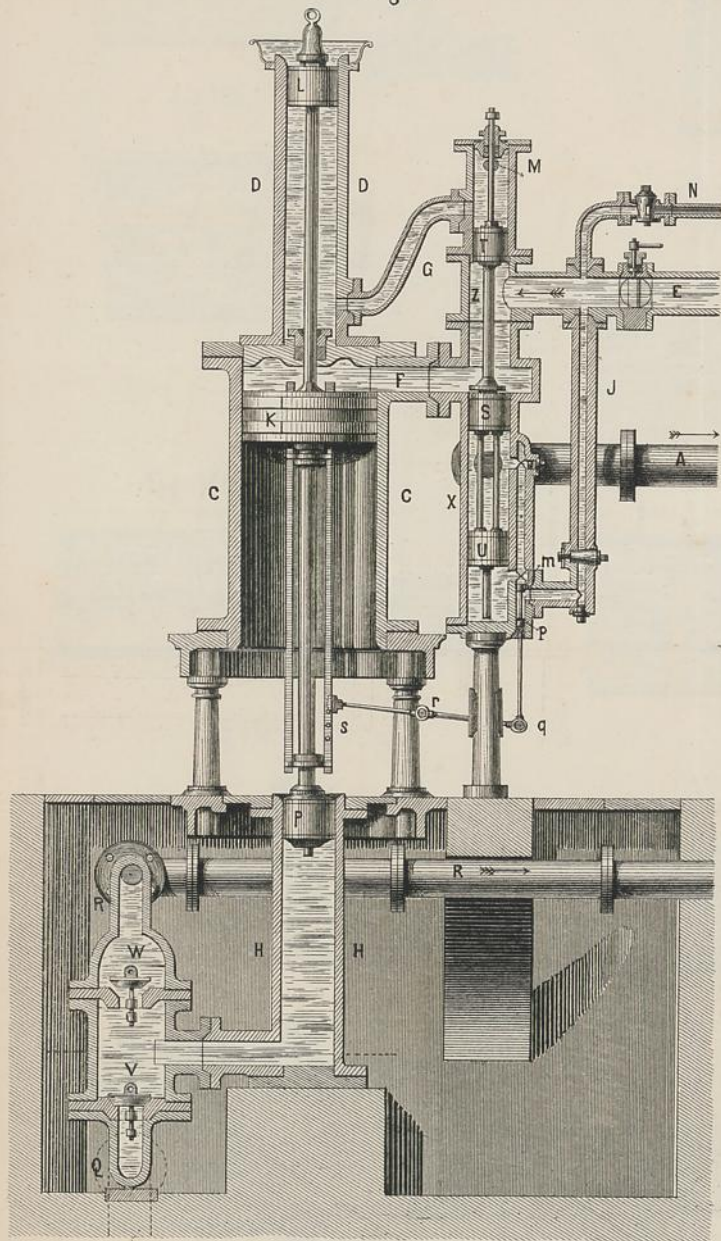

Fig. 98.

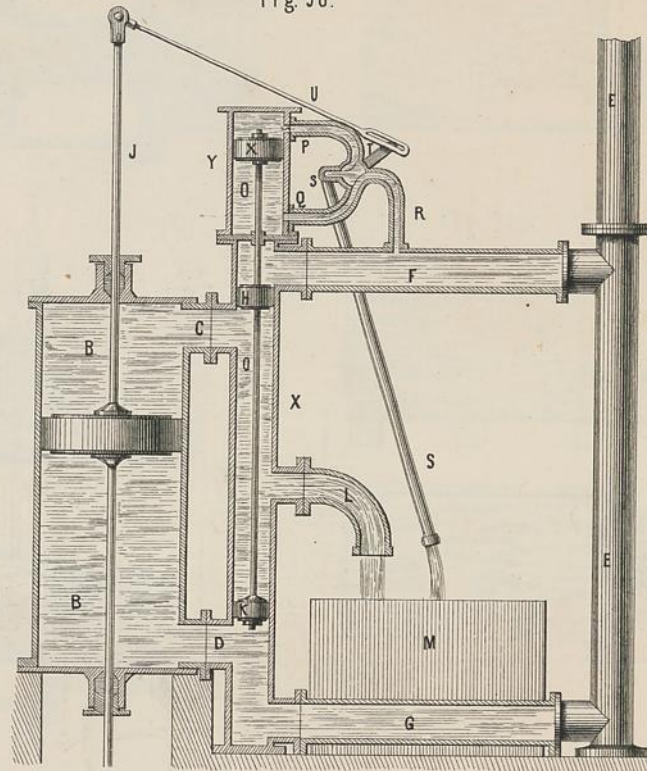

Fig. 101.

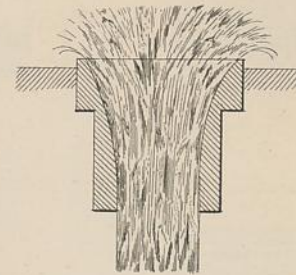

Fig. 102.

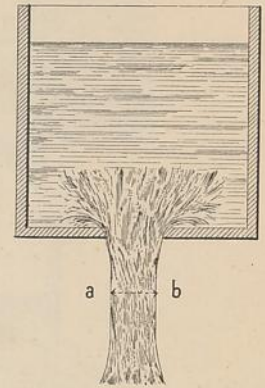

Fig. 103.

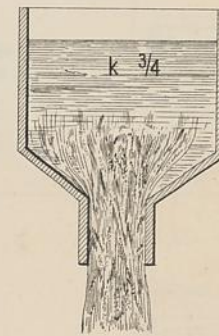

Fig. 104.

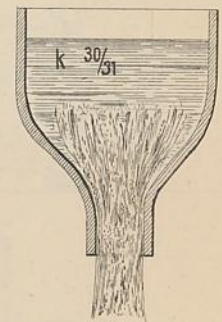

Fig. 105.

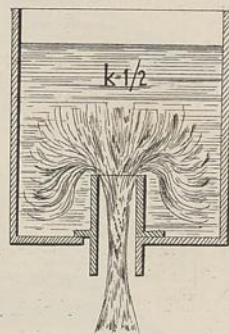

Fig. 106.

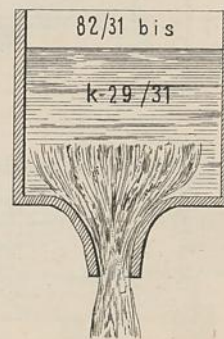

Fig. 107.

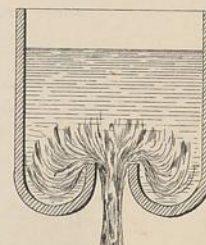
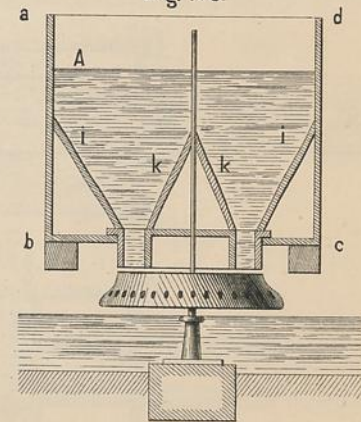
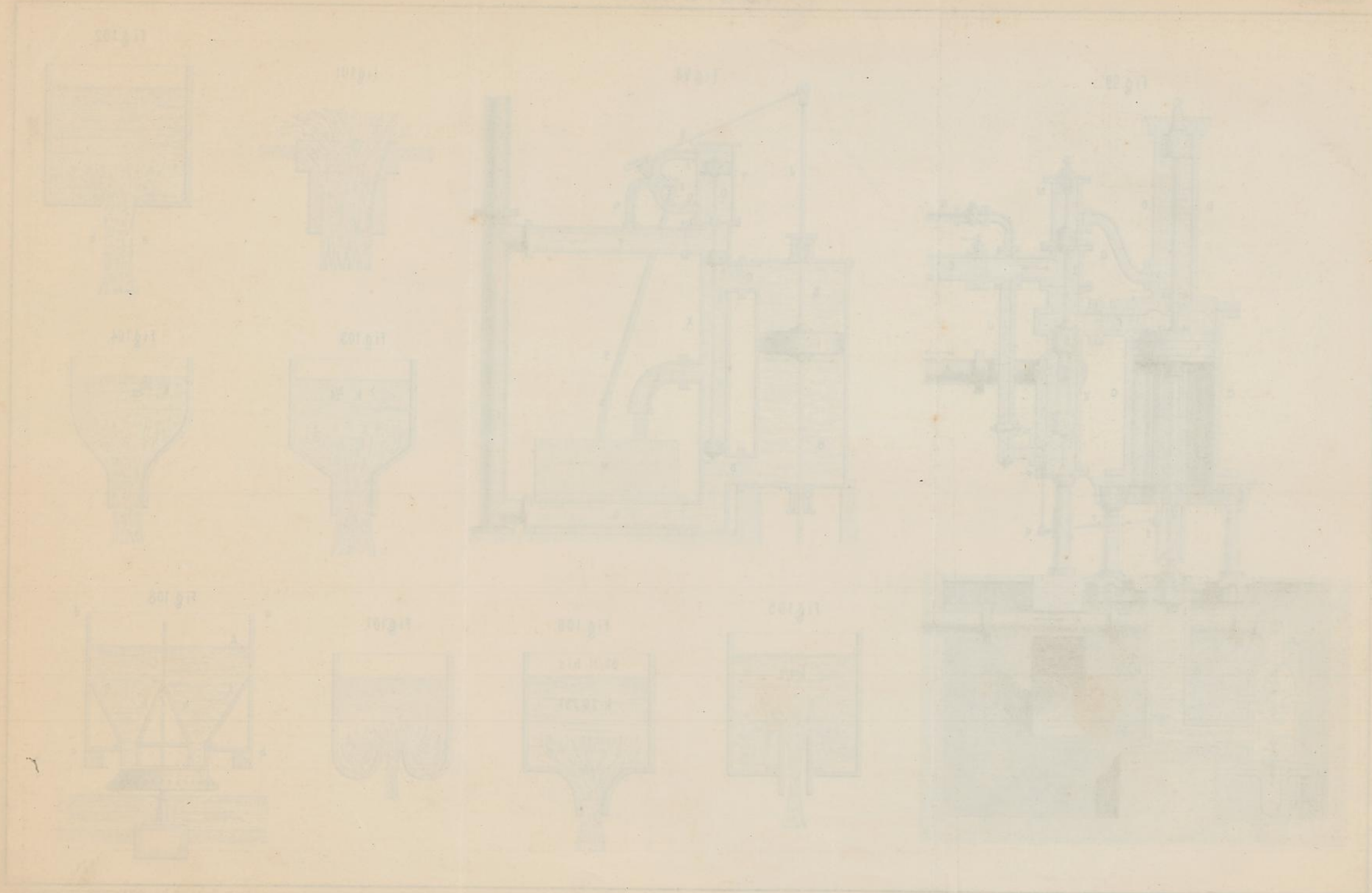

Fig. 108.





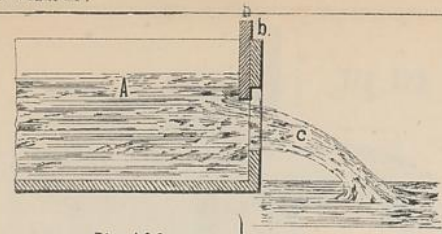

Fig. 109.

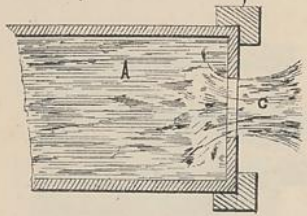

Fig. 110.

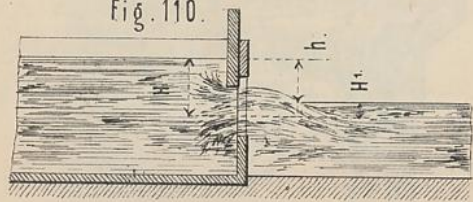

Fig. 111.

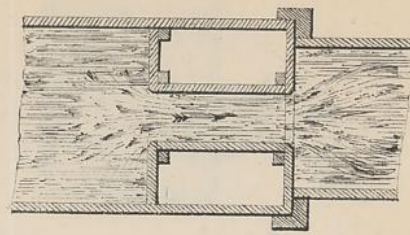
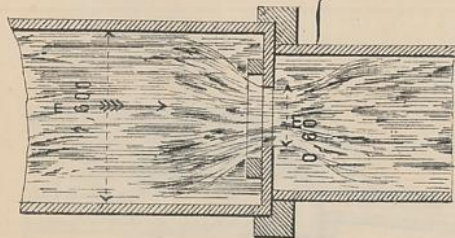
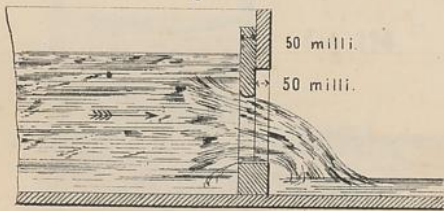

Fig. 114.

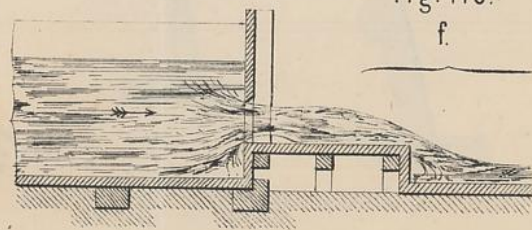
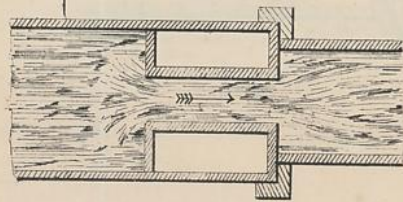
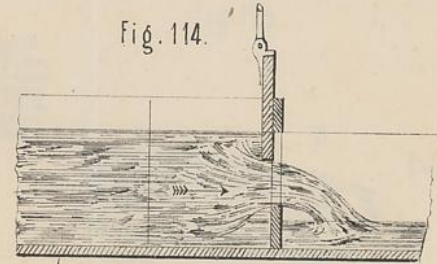
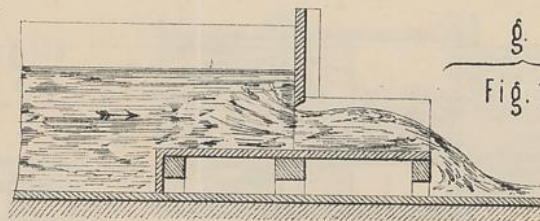

Fig. 118.

f.



g.

Fig. 119.

Fig. 112.

b.

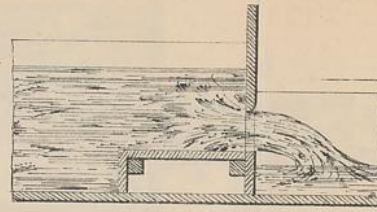

Fig. 115.

d.

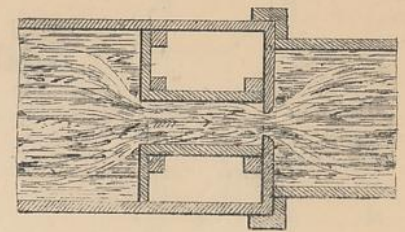
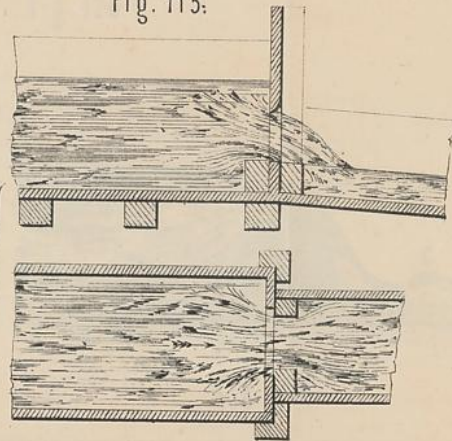

Fig. 120.

Fig. 116.

e.

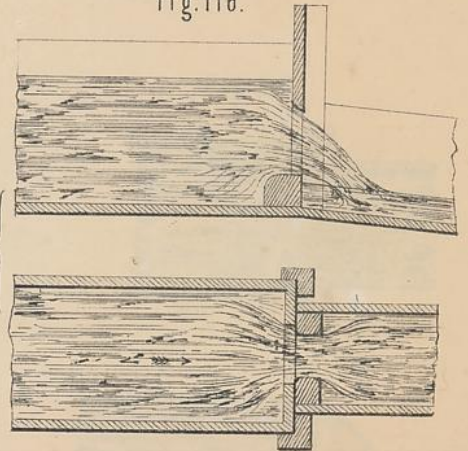

Fig. 120. h.

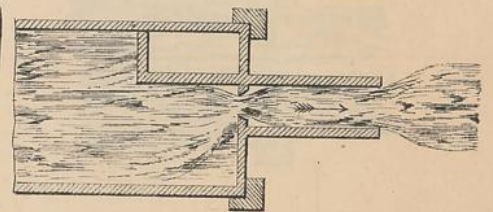
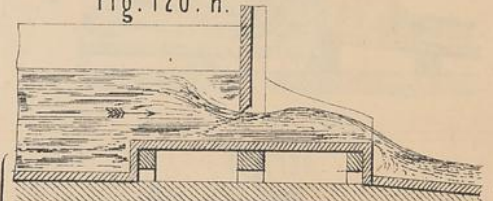
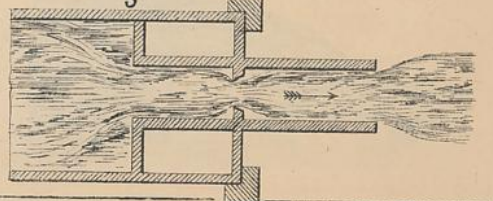
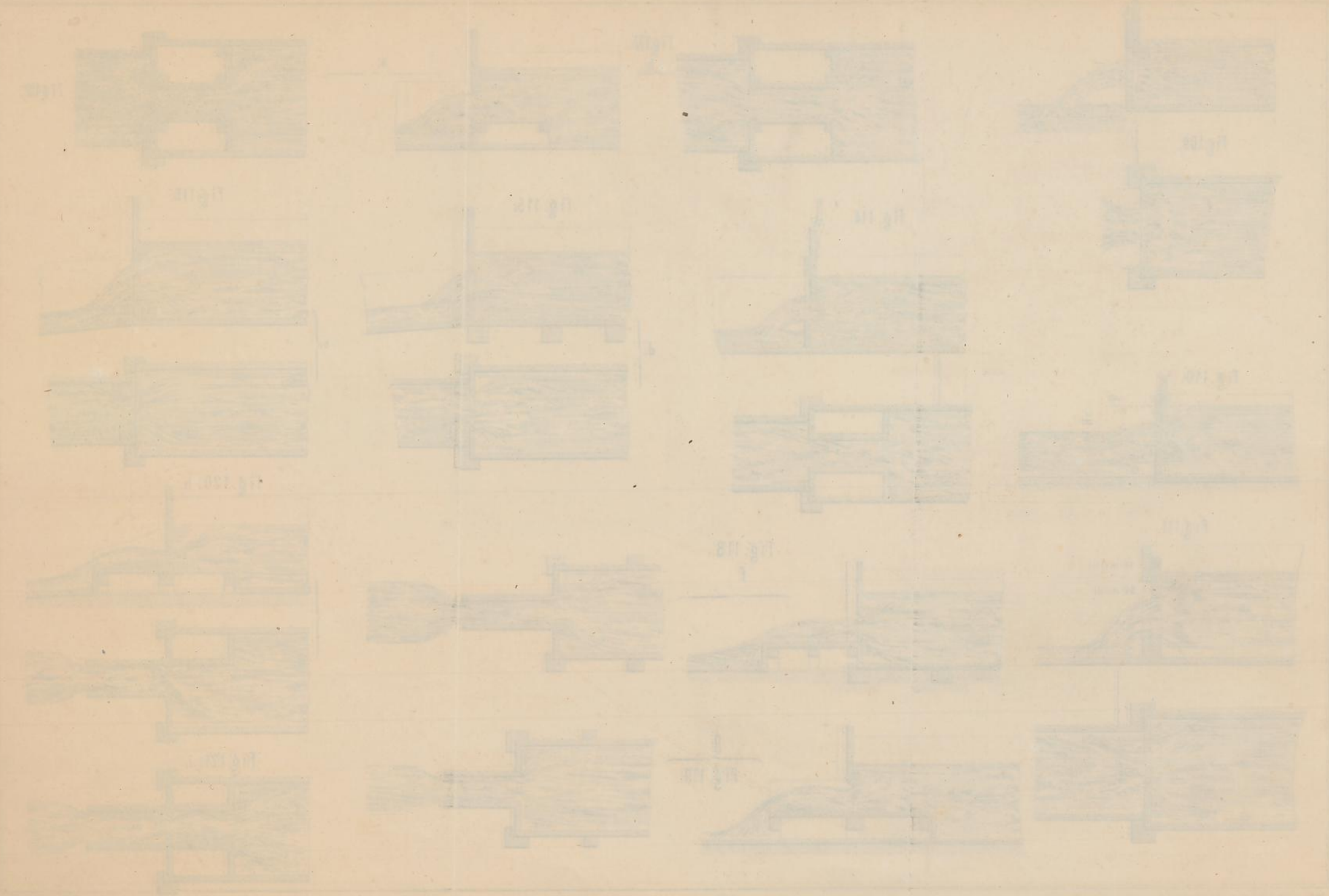

Fig. 121. i.





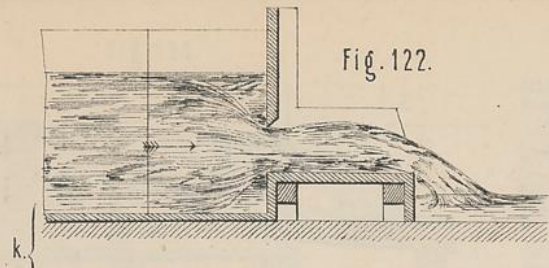

Fig. 122.

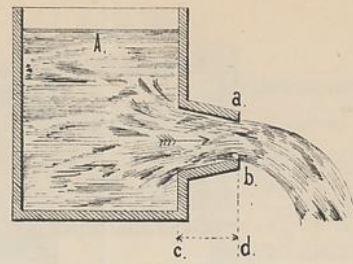

Fig. 125.

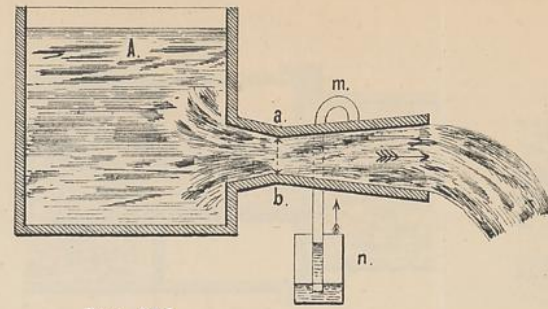

Fig. 126.

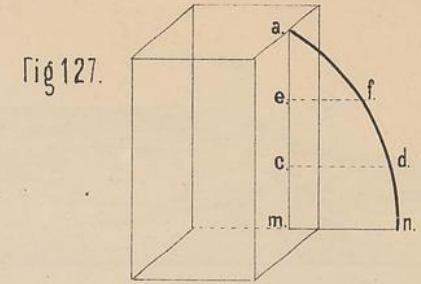

Fig. 127.

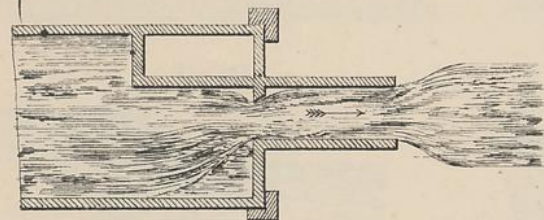

Fig. 123.

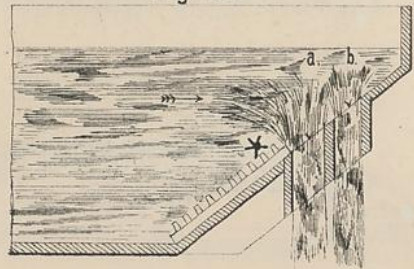

Fig. 124.

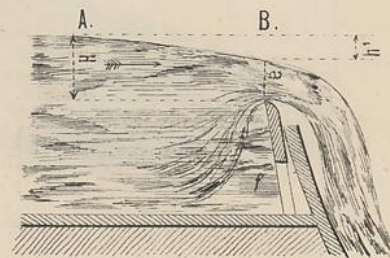

Fig. 128.

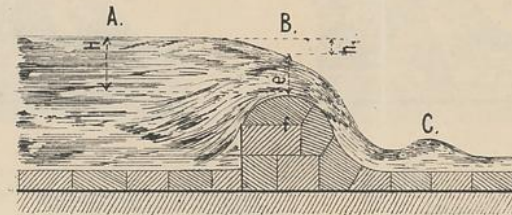

Fig. 129.

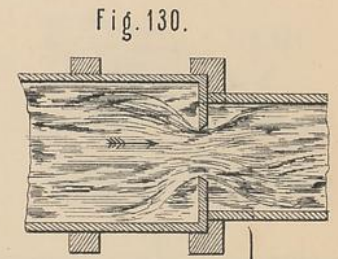

Fig. 130.

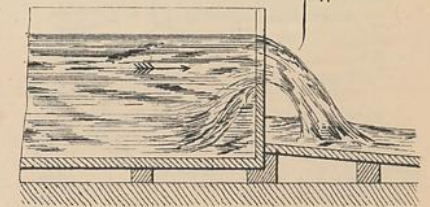

Fig. 131.

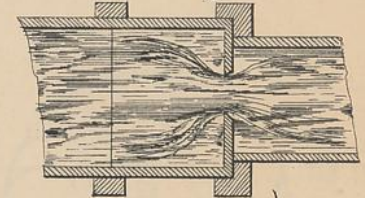

Fig. 132.

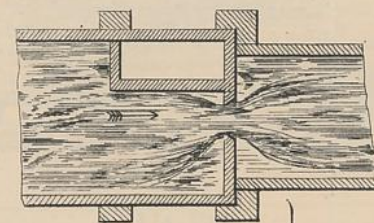

Fig. 133.

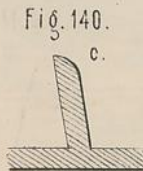
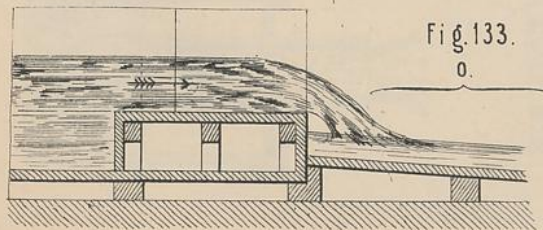

Fig. 140.

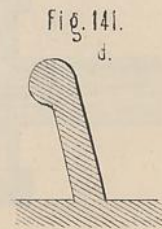
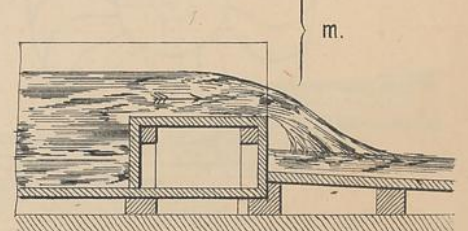
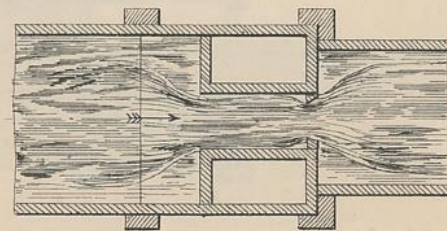

Fig. 141.



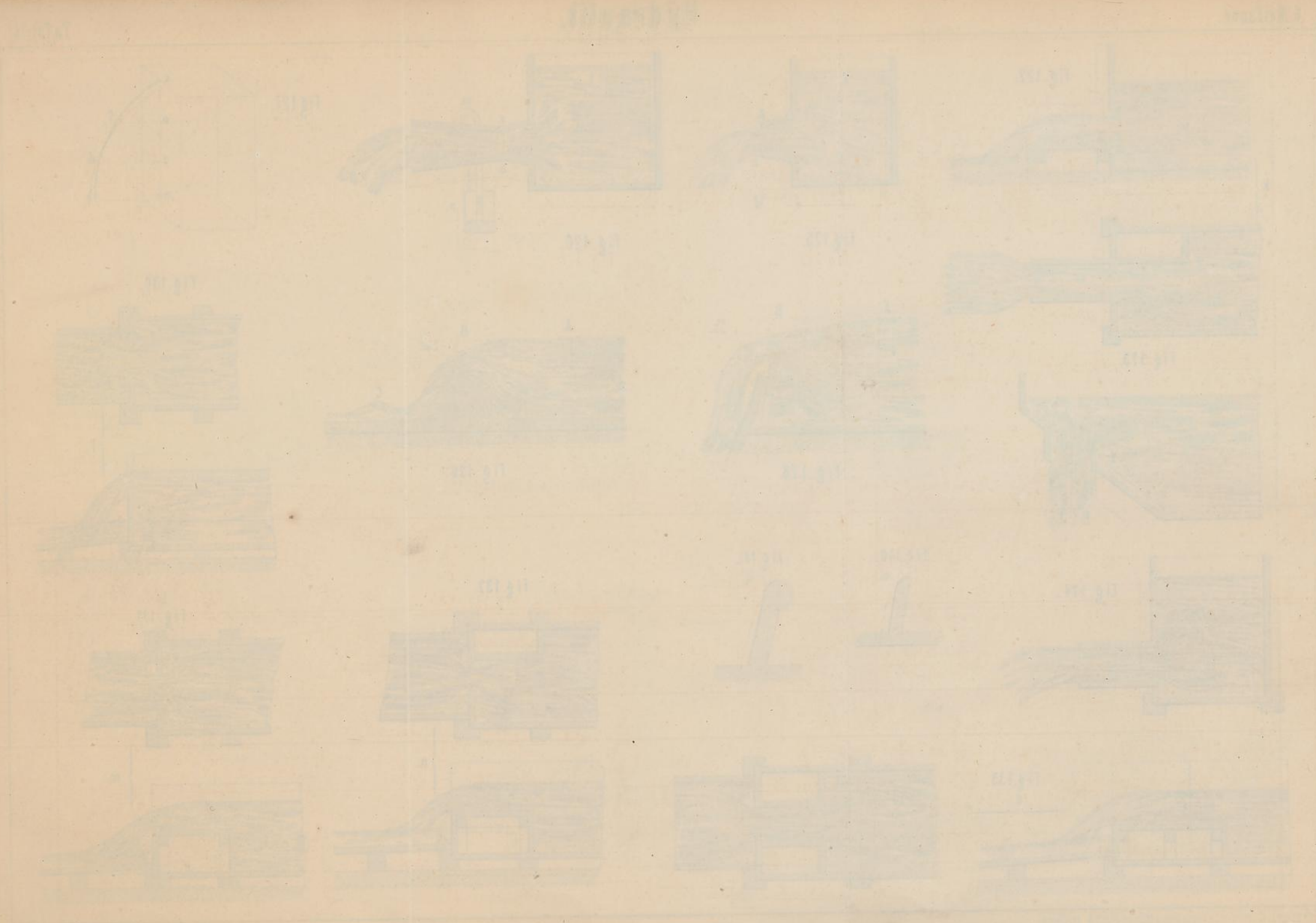
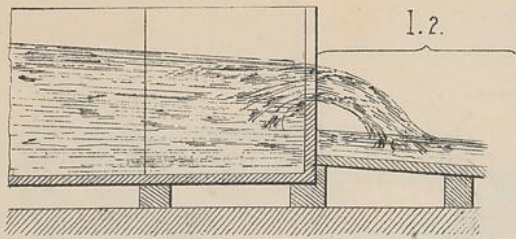
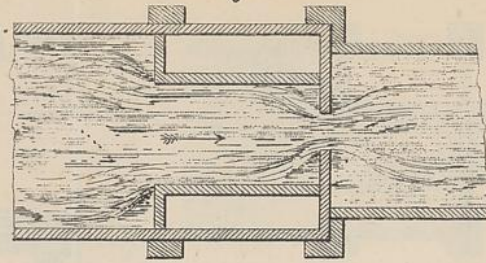

Fig. 134.



l. 4. Fig. 135.



l. 6. Fig. 135.

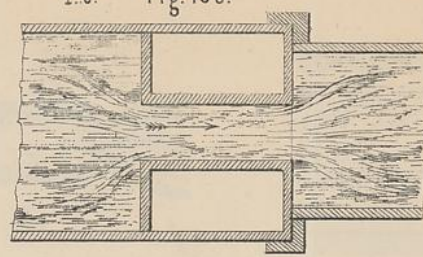

Fig. 136.

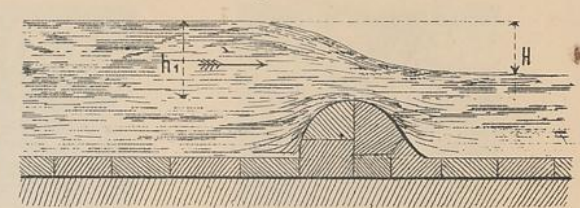

Fig. 137.

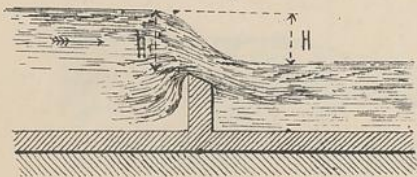

Fig. 138.

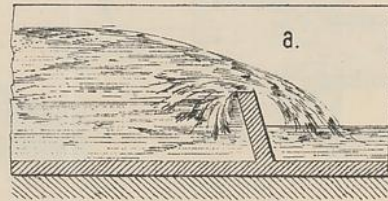

Fig. 139.

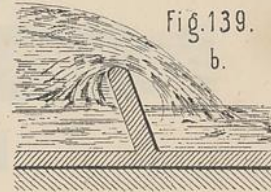

Fig. 140.

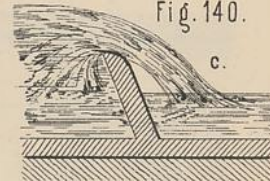

Fig. 141.

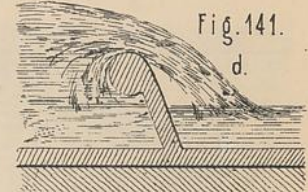

Fig. 142.

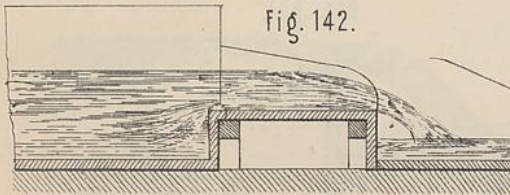

Fig. 143.

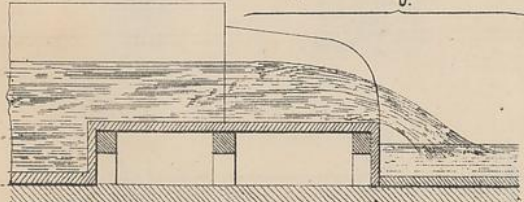

Fig. 145.

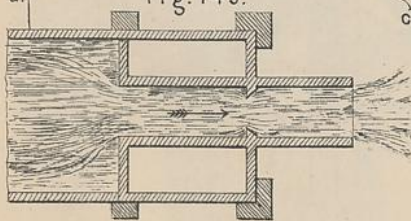

Fig. 144.

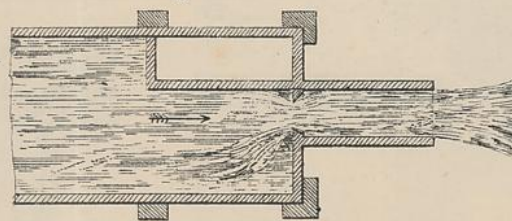

Fig. 149.

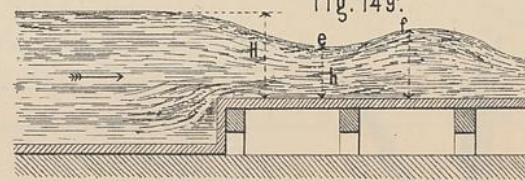

Fig. 150.

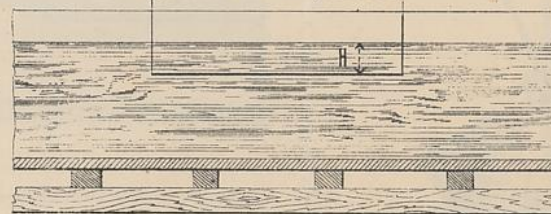

Fig. 152.

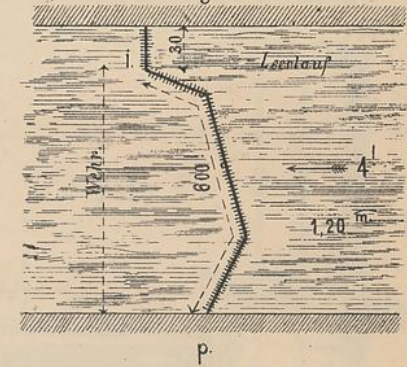

Fig. 151.

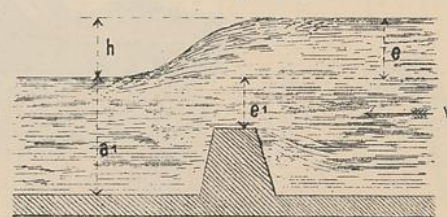
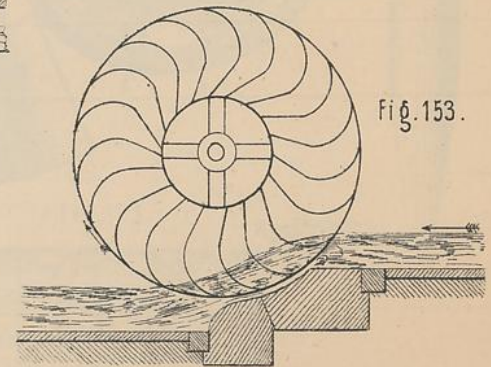
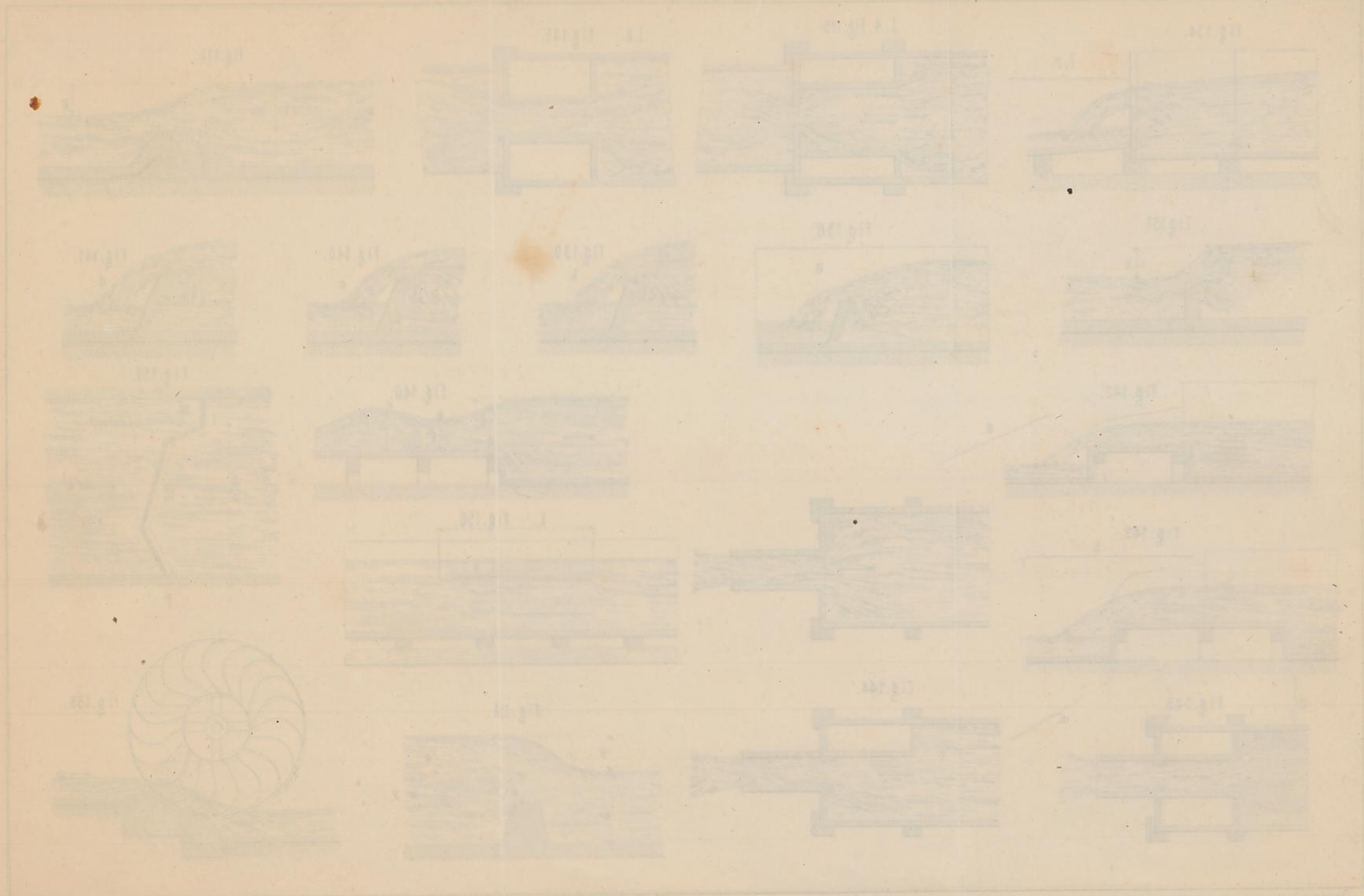
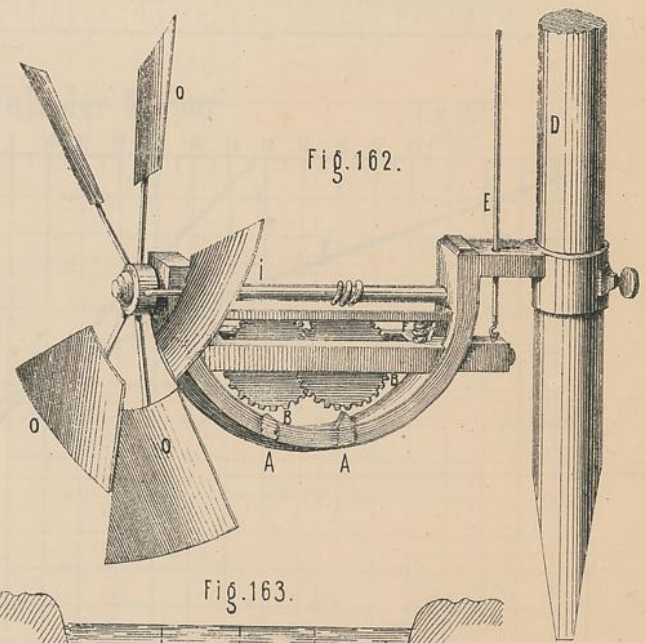
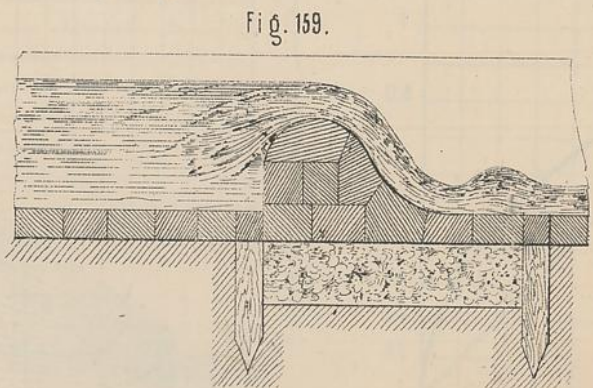
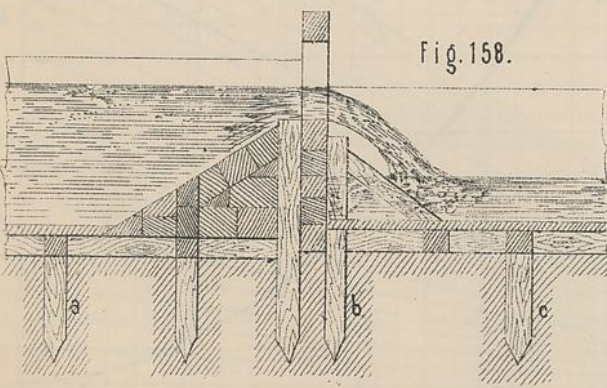
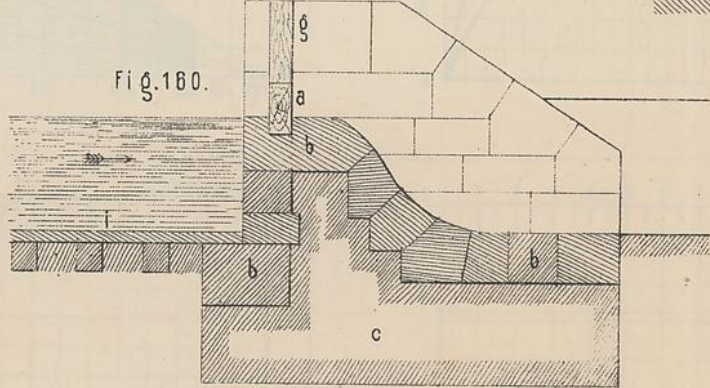
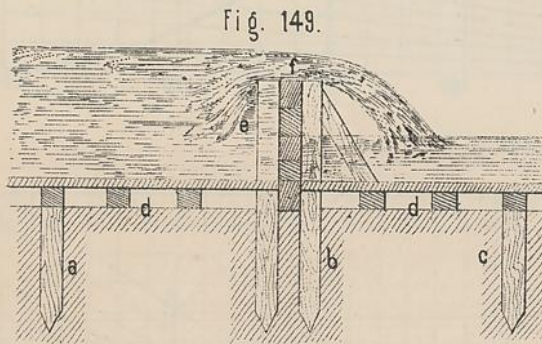
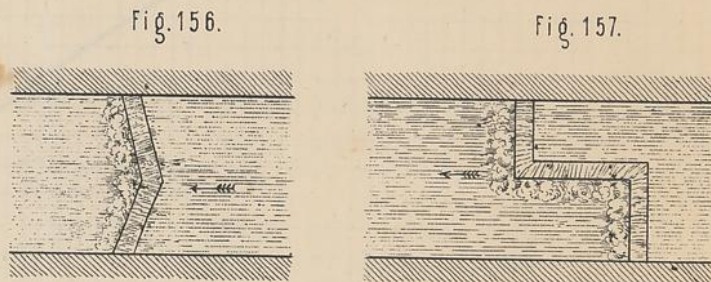
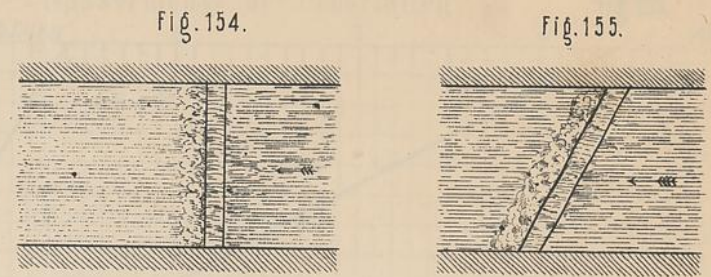
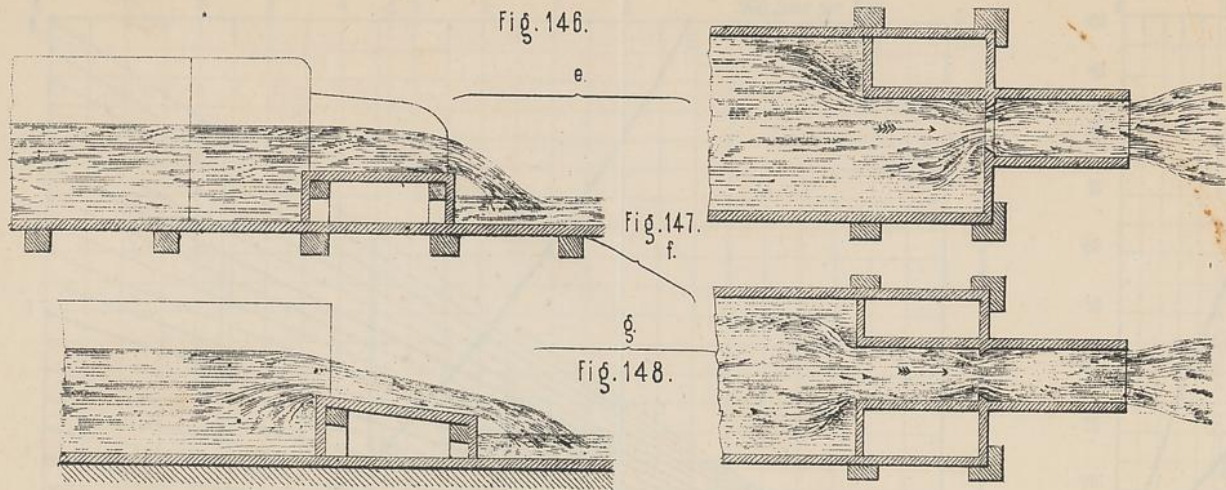

Fig. 153.







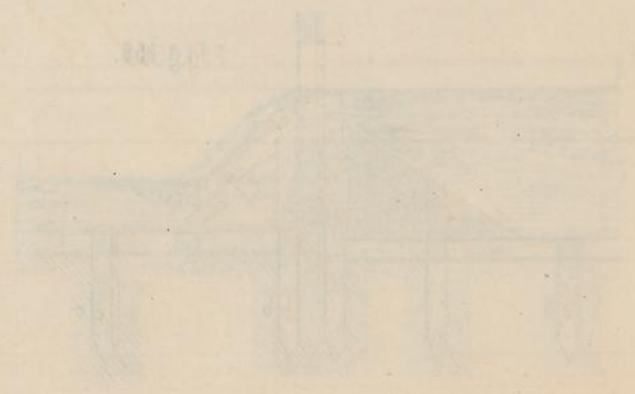
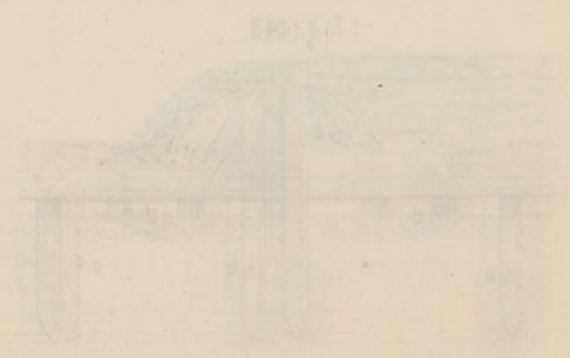
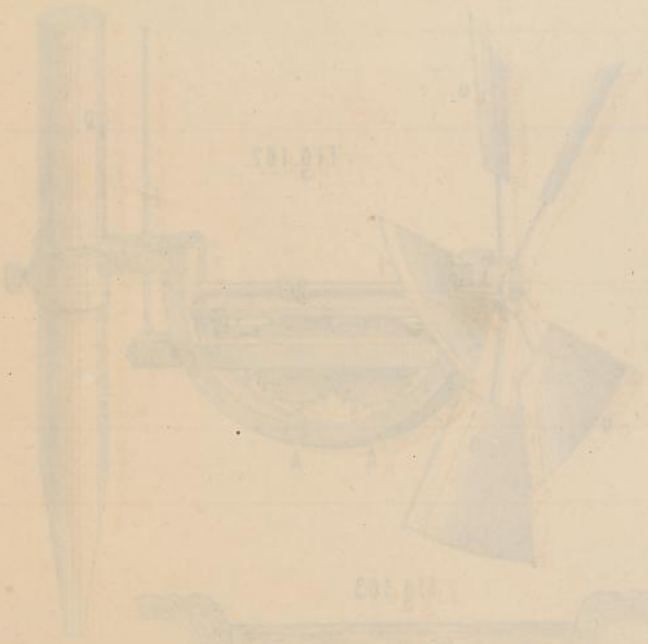
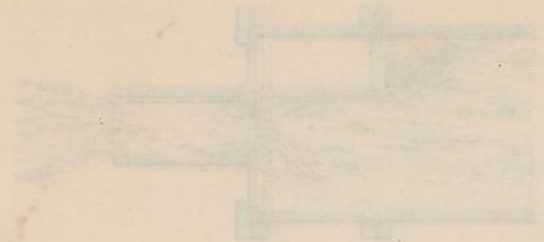
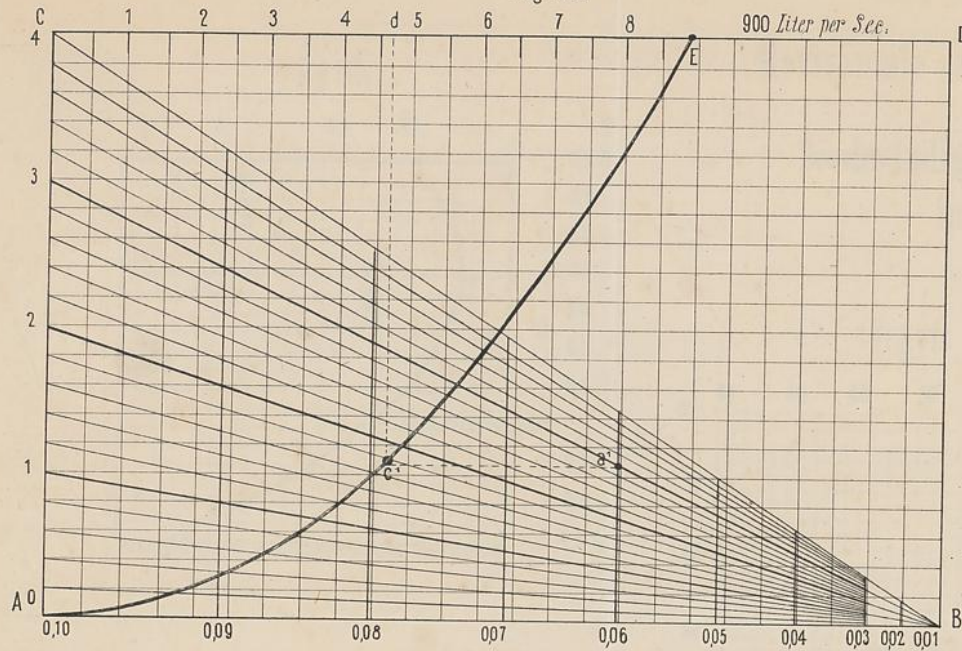

Fig 164.



Wassermenge bei Ueberfällen.

Fig 165.

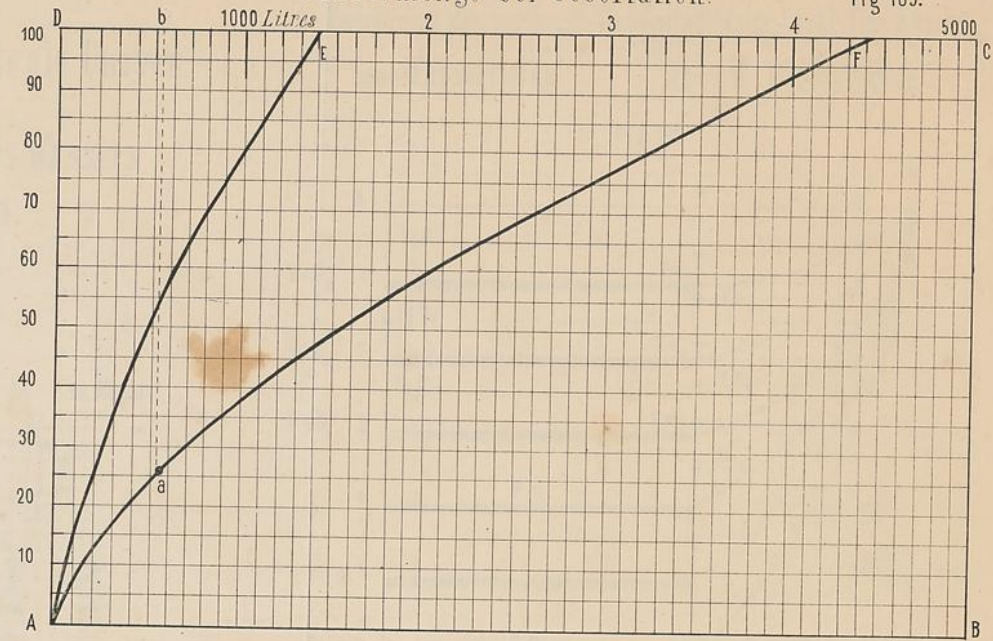
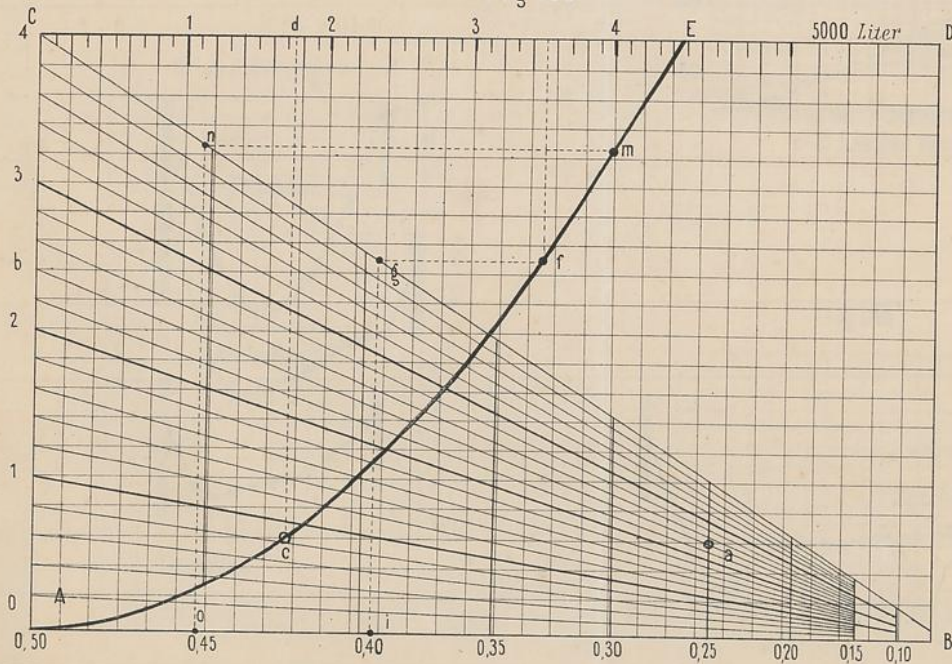
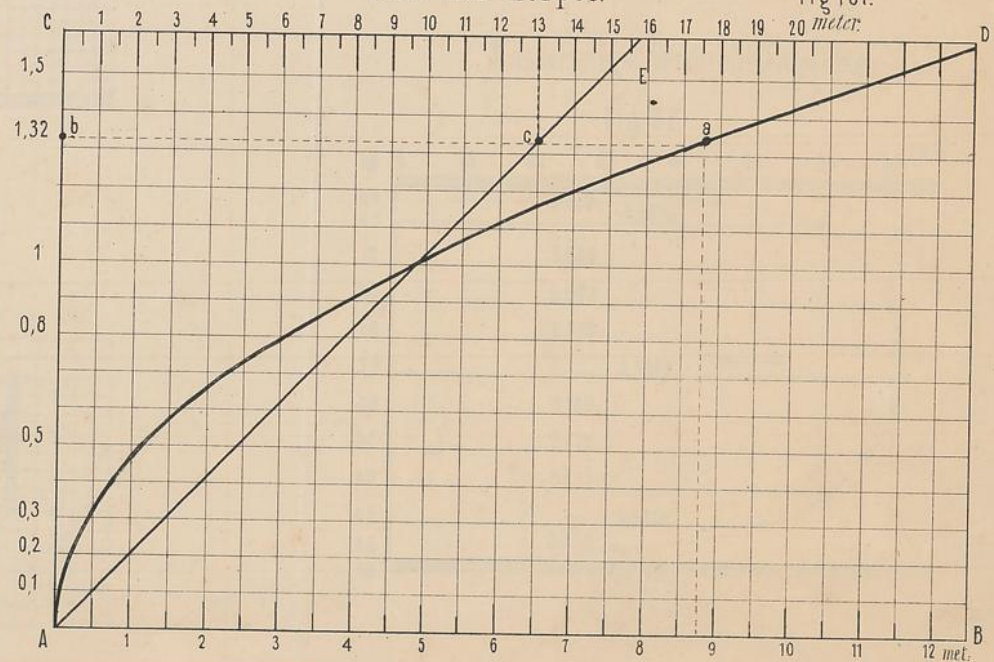

Fig 166.



Fall der Körper.

Fig 167.



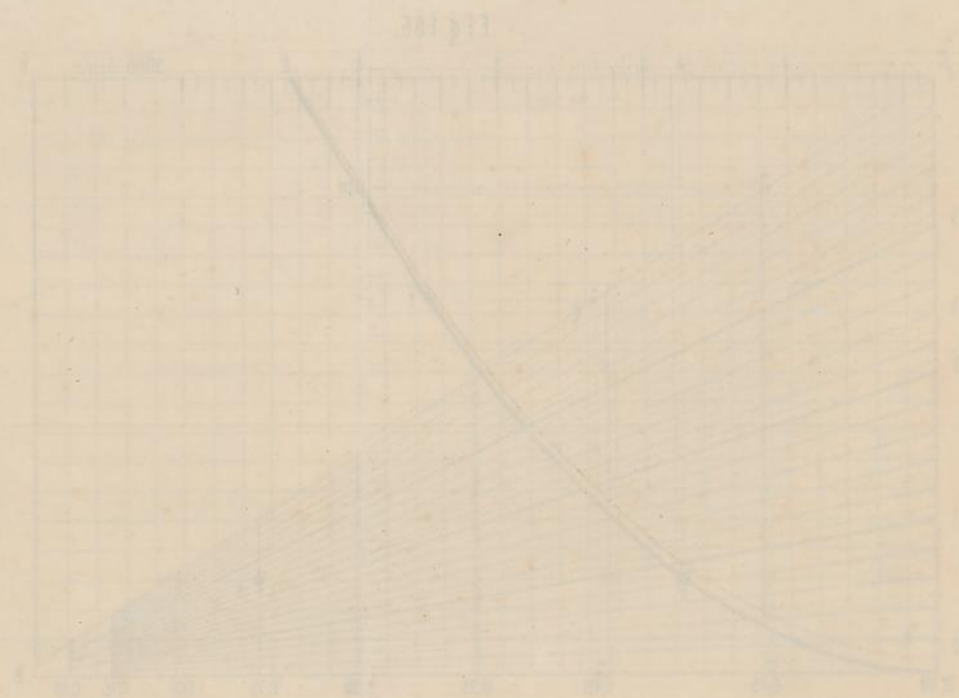
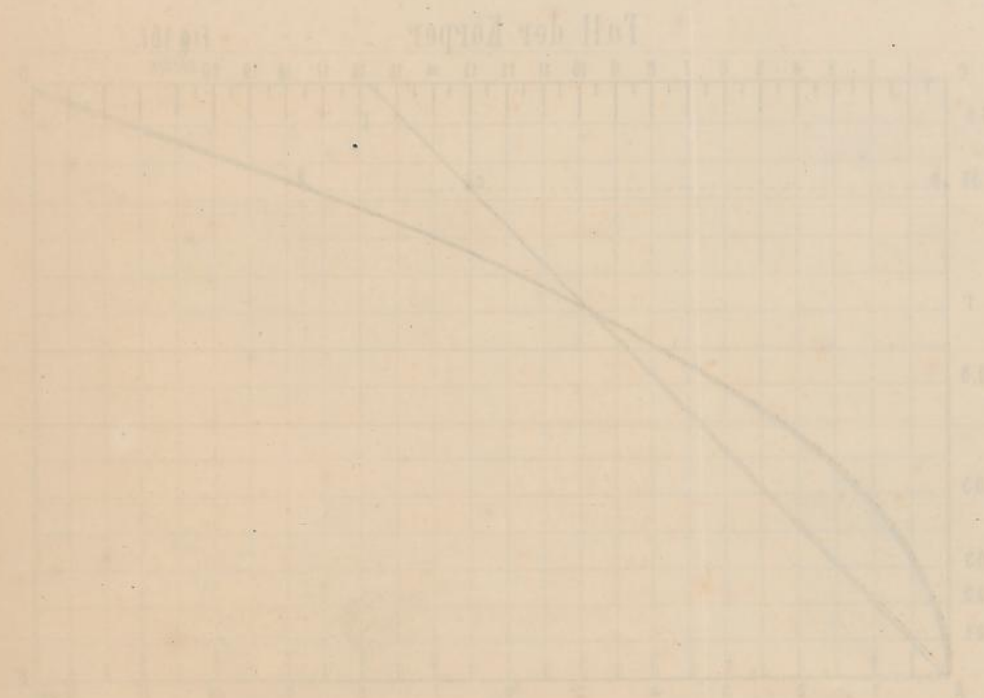
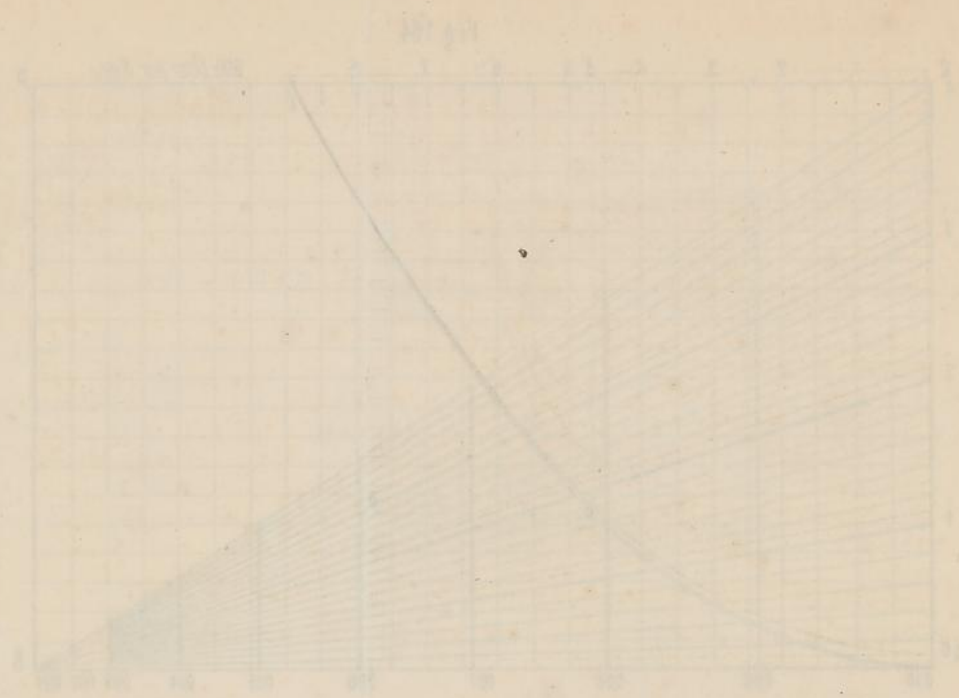
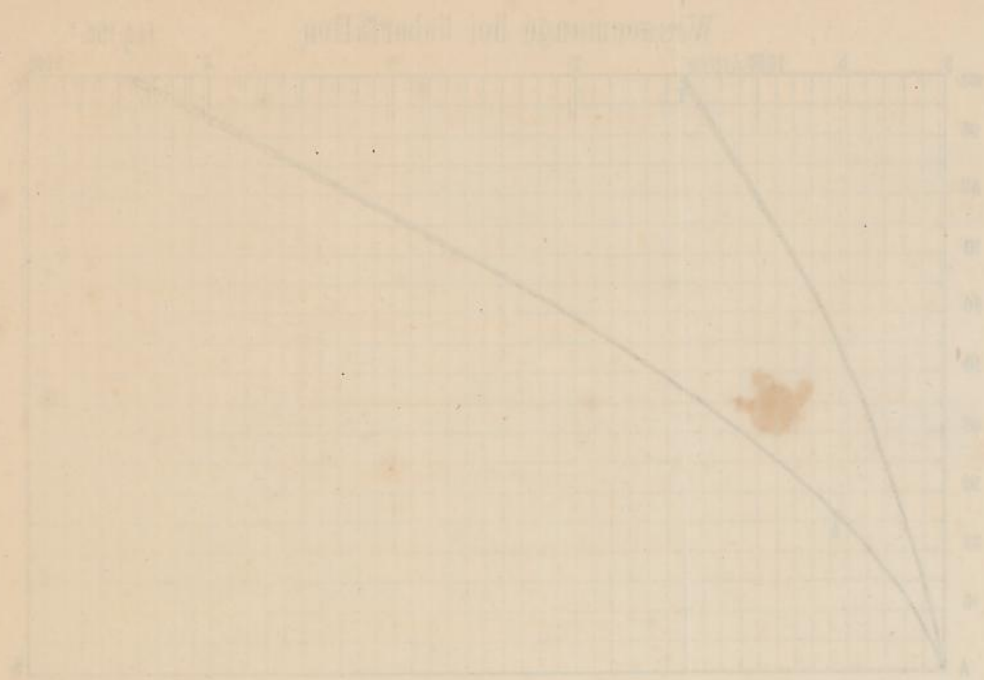

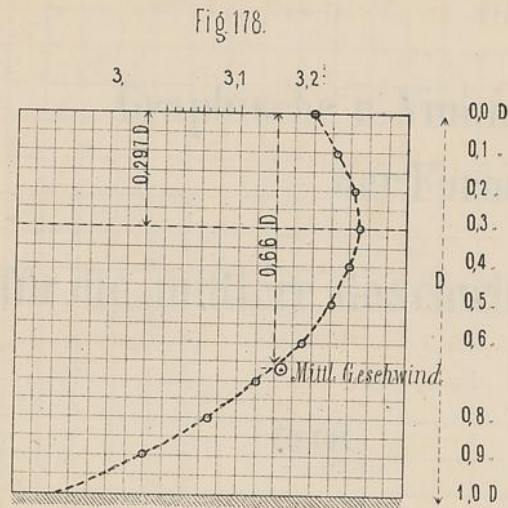

Horizontale u. verticale Curven
der
Geschwindigkeit des Wassers
in Flüssen.

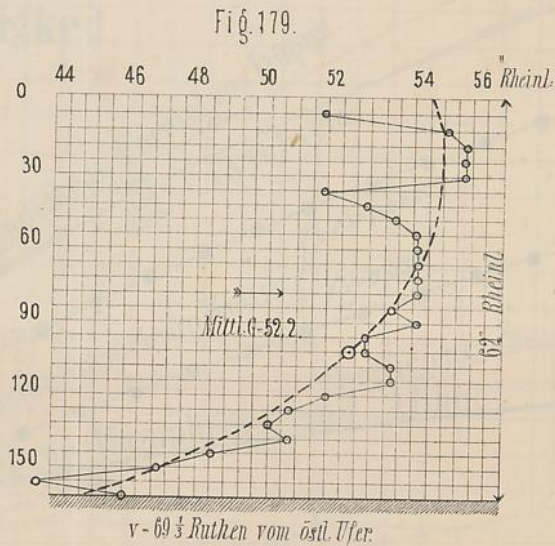

Verhältnisse der verticalen Geschwindigkeits-Parab. für verschie-
dene Wassertiefen. Axe am Wasserspiegel.

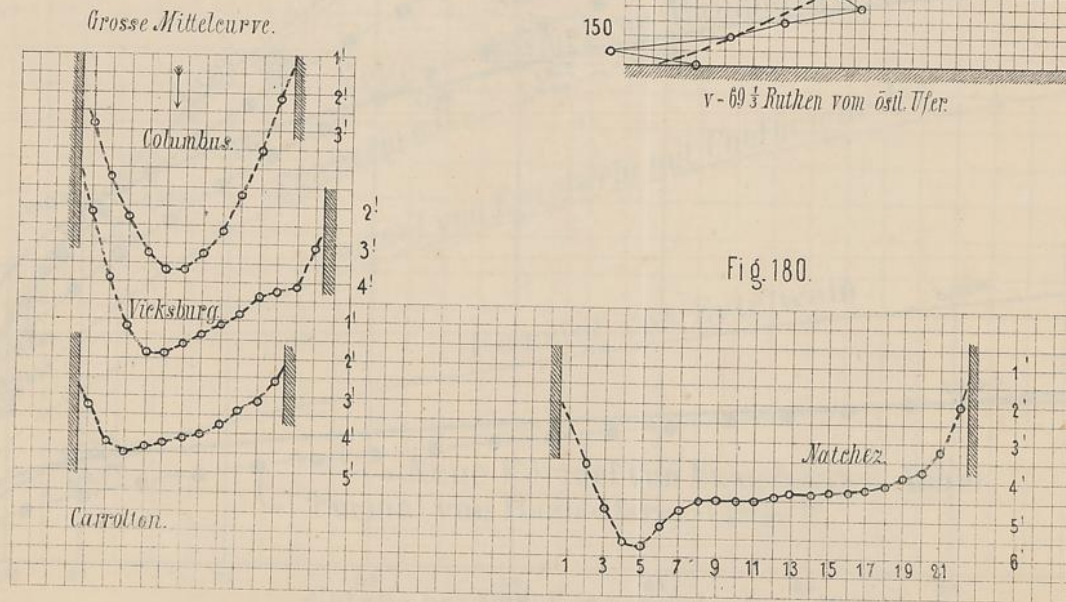
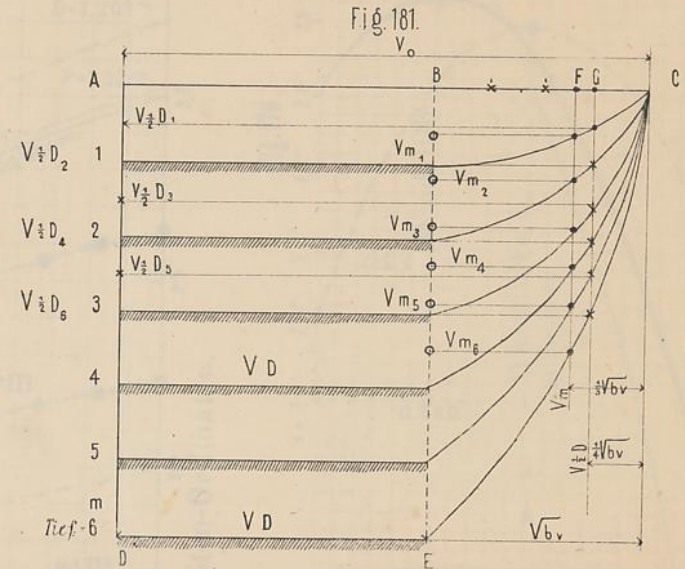

Wasserspiegel-Geschwindigkeits-Curve.

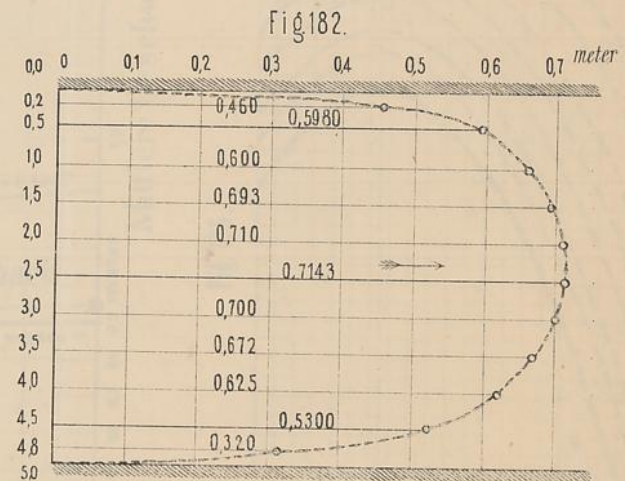

Bestimmung der mitteln Geschwindigkeit v_m in Röhren

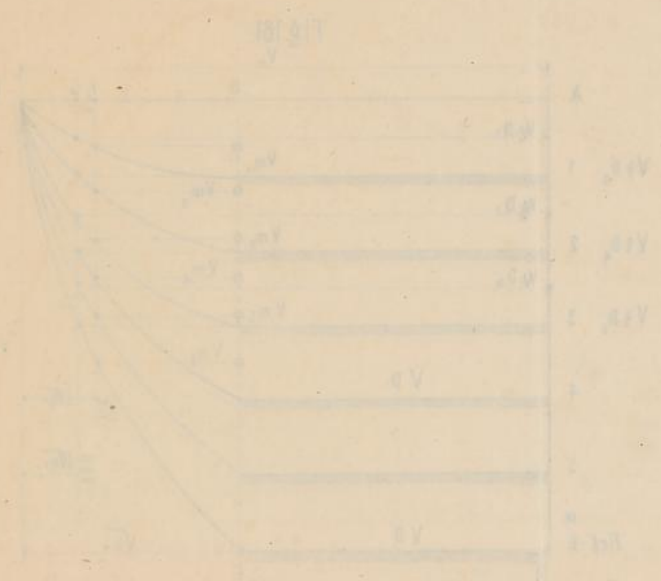

Horizontale u. vertikale Kurven
Geschwindigkeit des Wassers
in Röhren

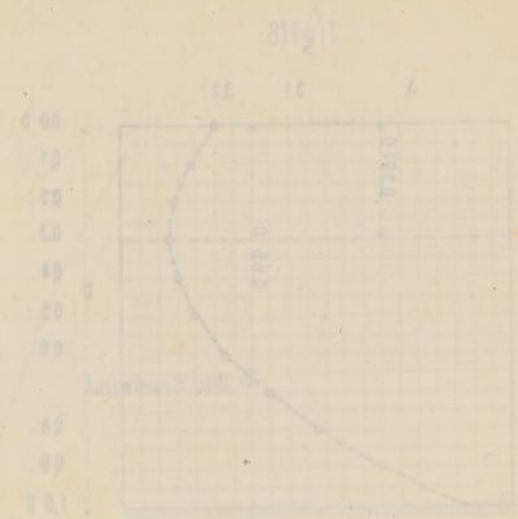
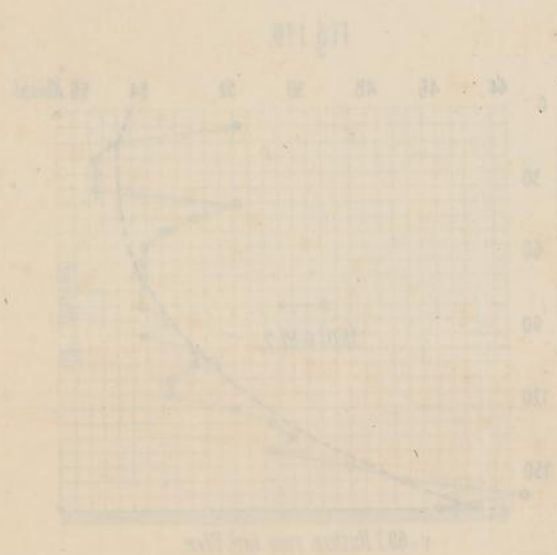

Korrekturen

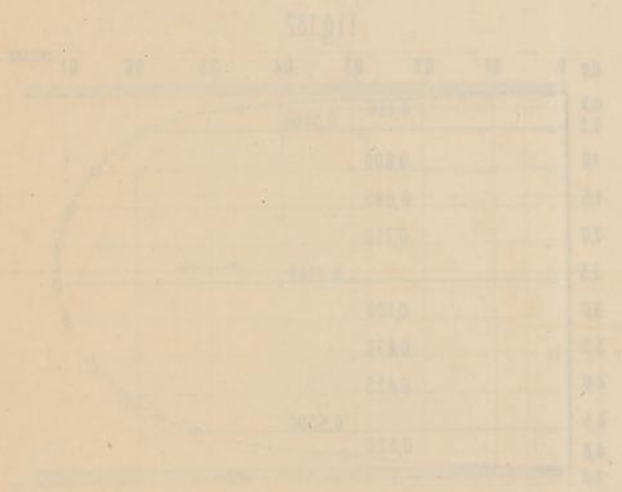

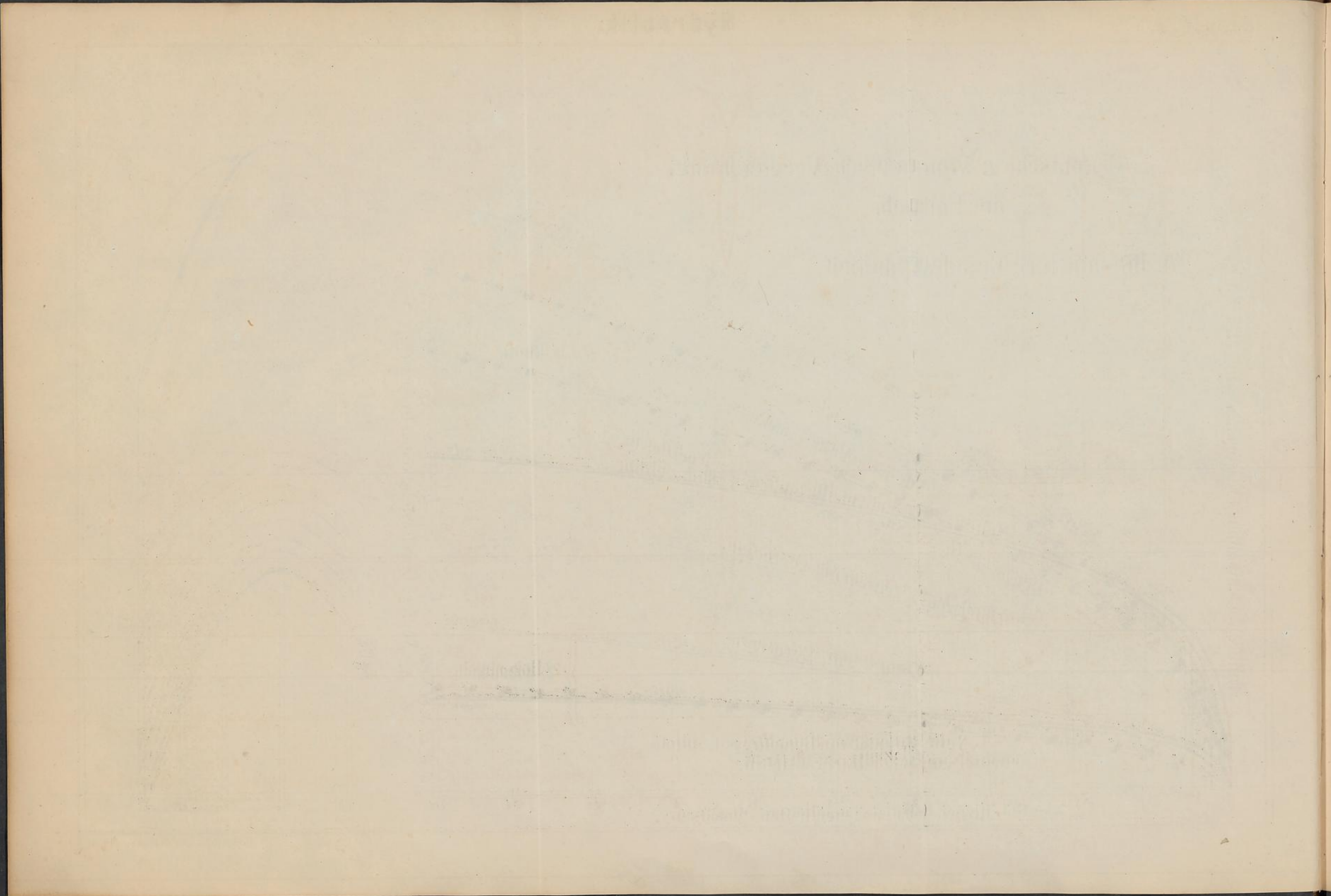

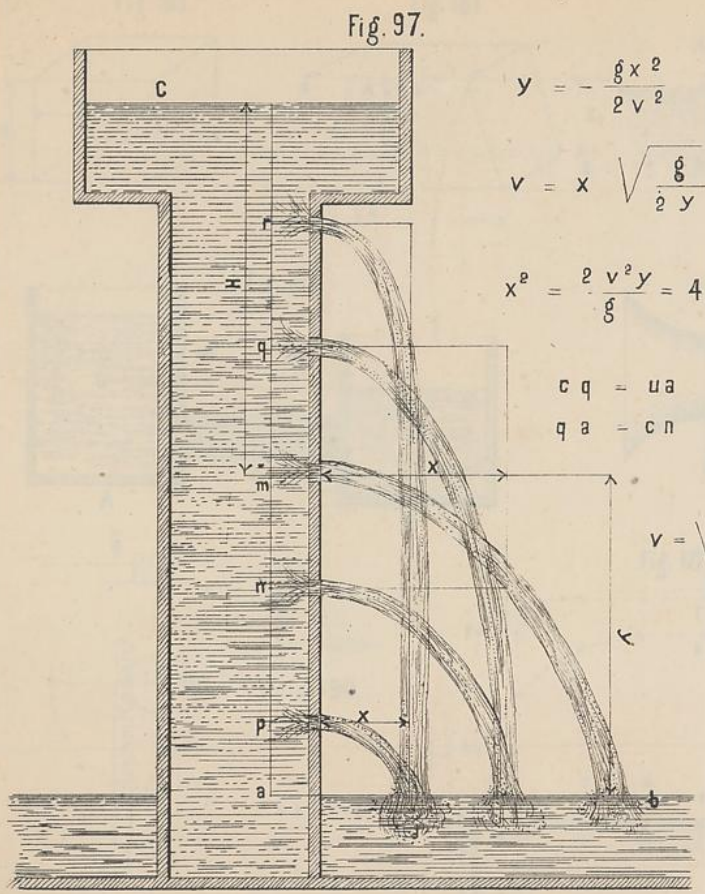

Fig. 97.

$$y = -\frac{g x^2}{2 v^2}$$

$$v = x \sqrt{\frac{g}{2 y}}$$

$$x^2 = \frac{2 v^2 y}{g} = 4 H y.$$

$$c q = u a$$

$$q a = c n$$

$$v = \sqrt{2 g H}.$$

Fig. 177.

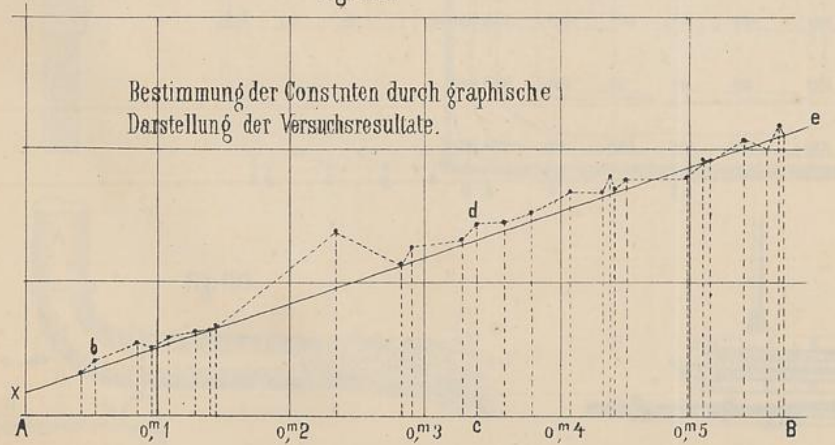

Bestimmung der Constanten durch graphische Darstellung der Versuchsergebnisse.

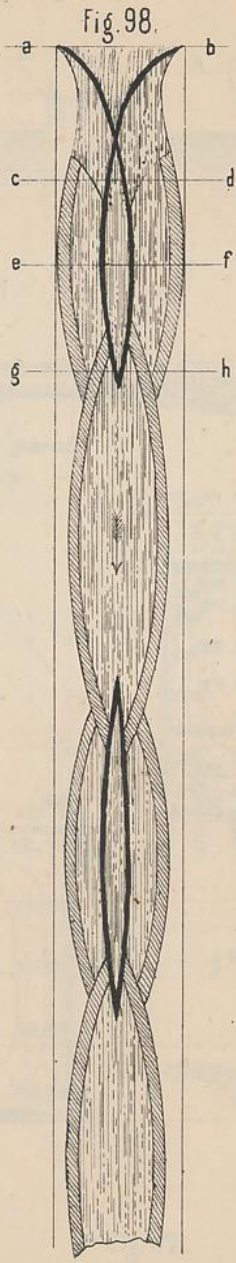
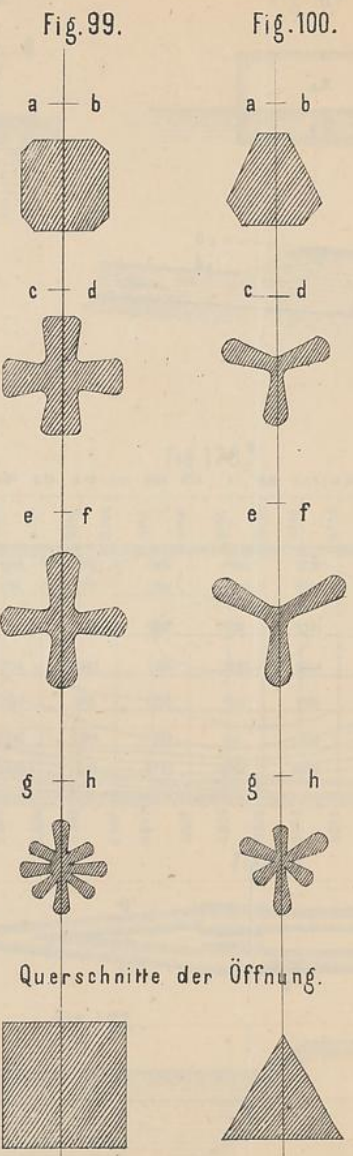
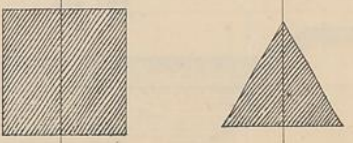

Fig. 98.



Querschnitte der Öffnung.



Die aufeinanderfolgenden Querschnitte der vertical ausfließenden Wasserstrahlen.

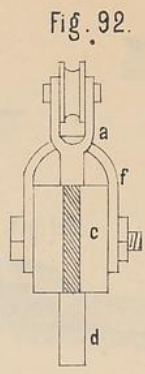

Fig. 92.

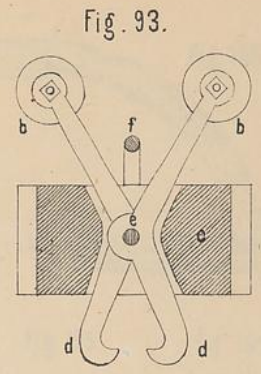

Fig. 93.

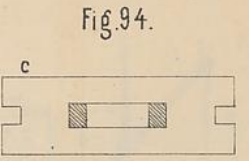

Fig. 94.

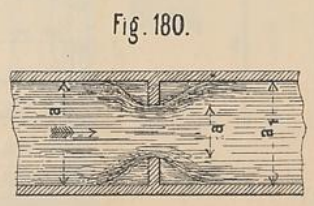

Fig. 180.

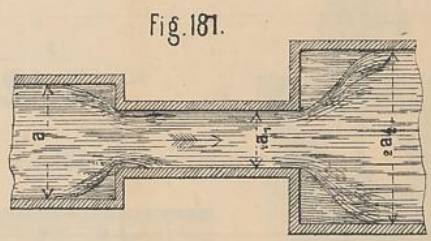

Fig. 181.

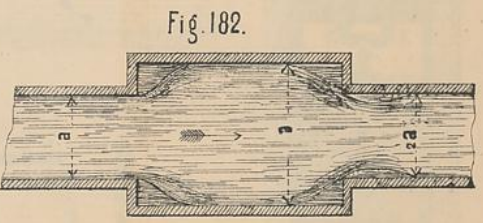

Fig. 182.

Fig. 97

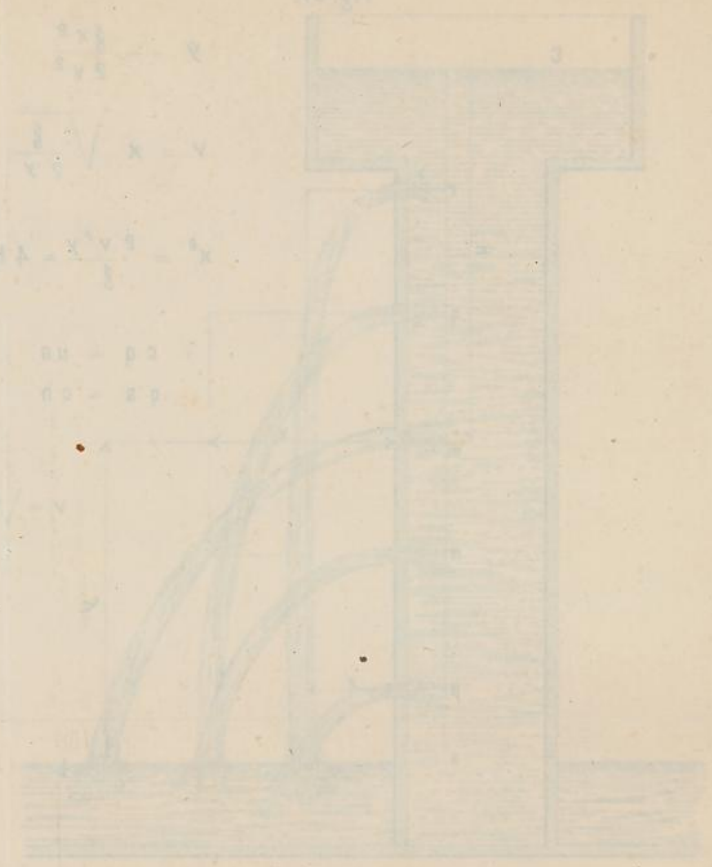

Fig. 97

Bestimmung der Kräfte durch graphische
Bestimmung der Kräfte durch graphische

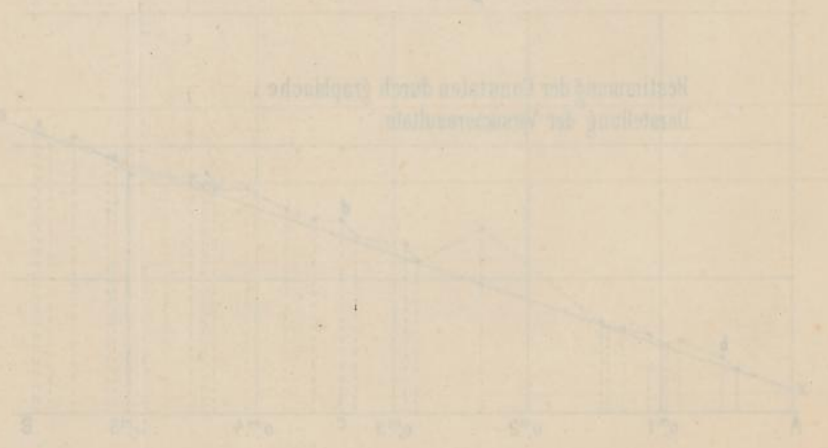

Fig. 98



Fig. 99



Fig. 100



Querschnitte der Öffnung

Die aufeinanderfolgenden Querschnitte
der vertical auslaufenden Wasserstrahlen

Fig. 95



Fig. 96



Fig. 94



Fig. 100

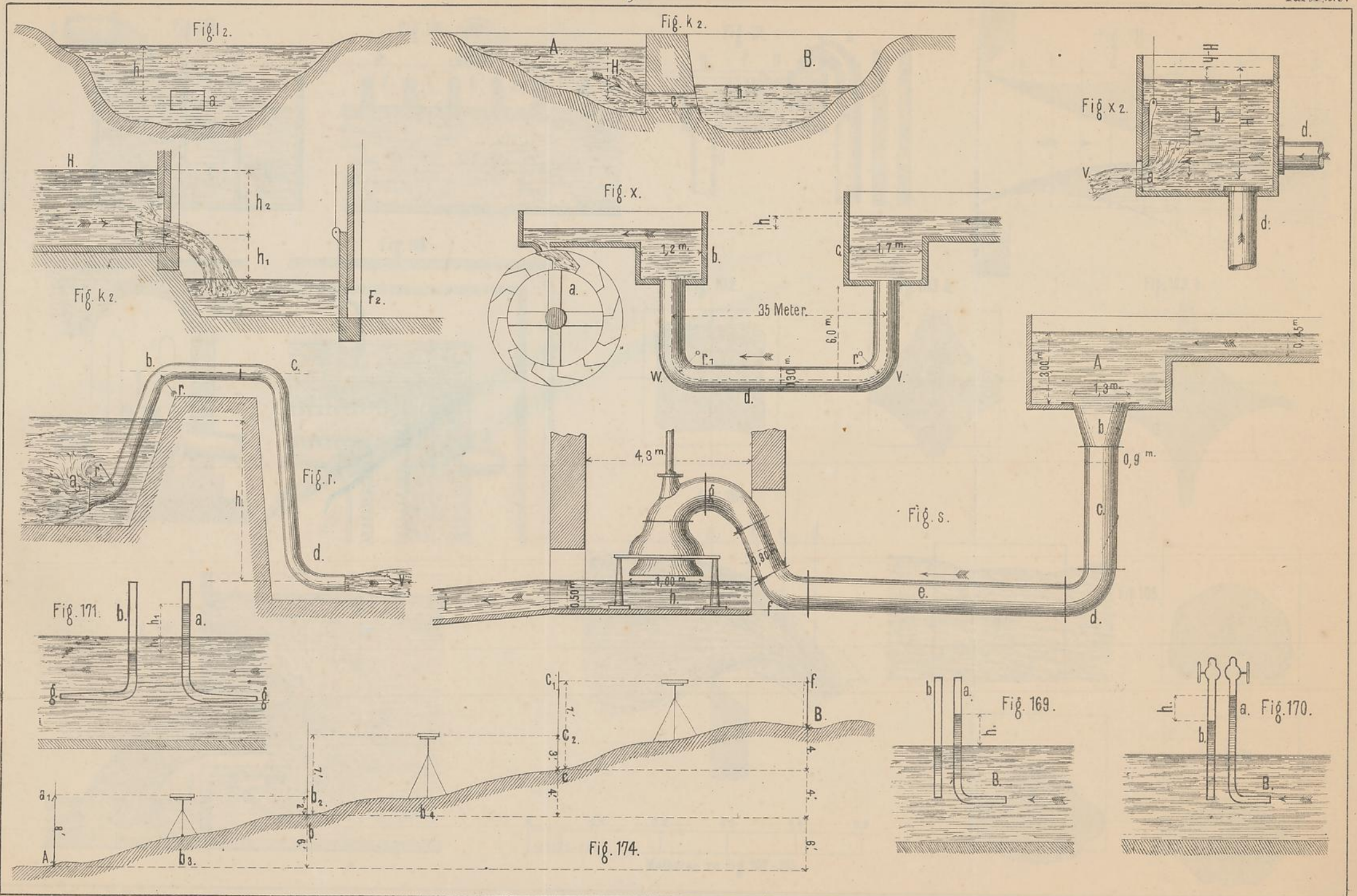

Fig. 101



Fig. 102





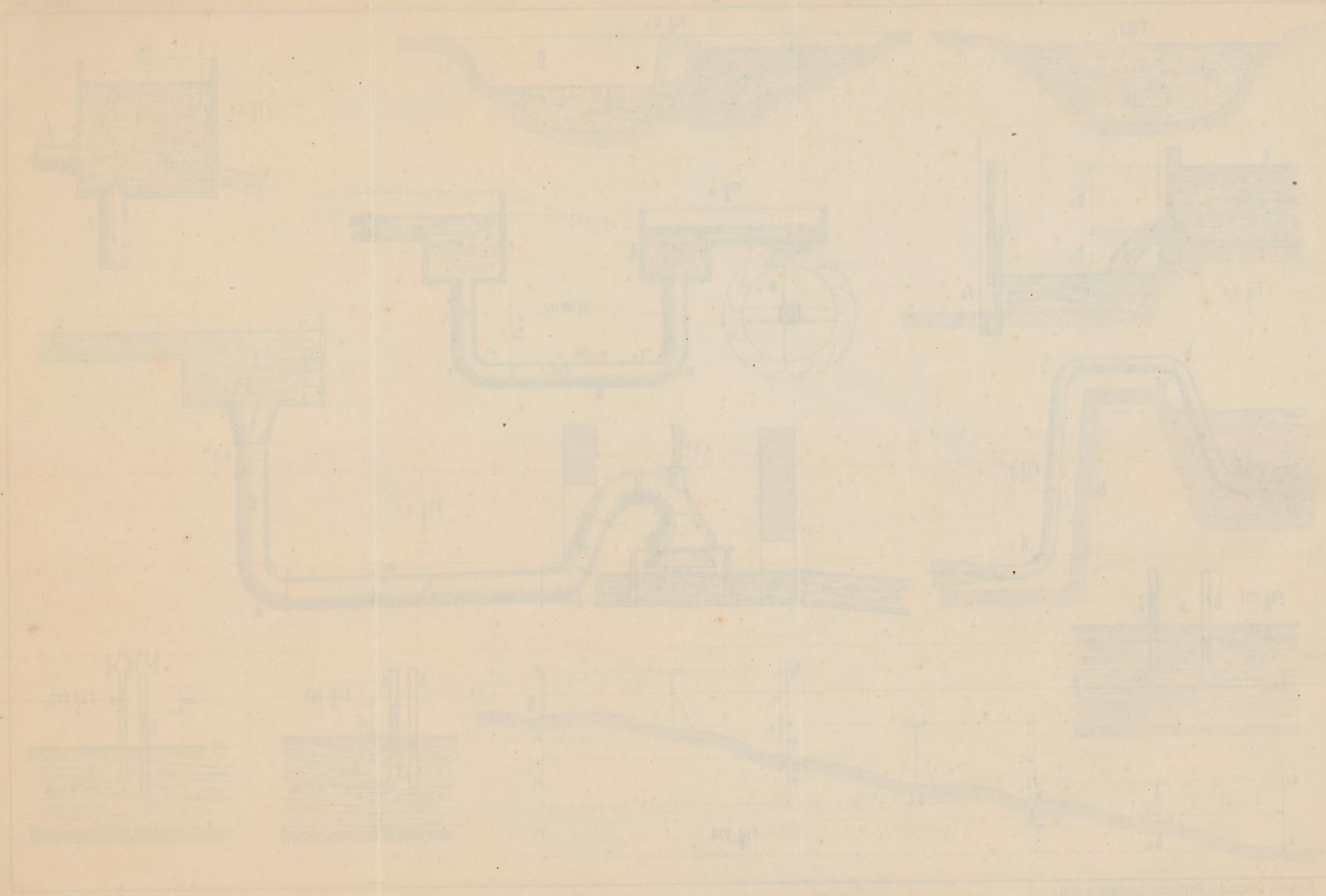

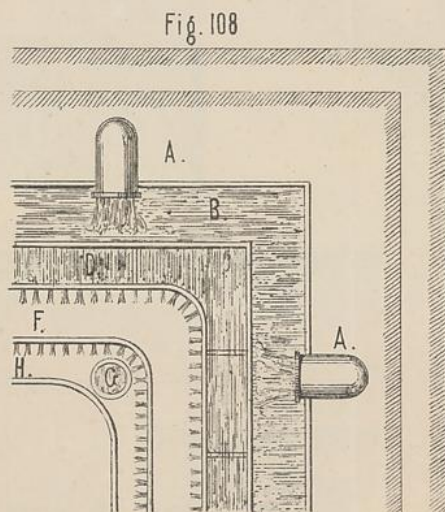
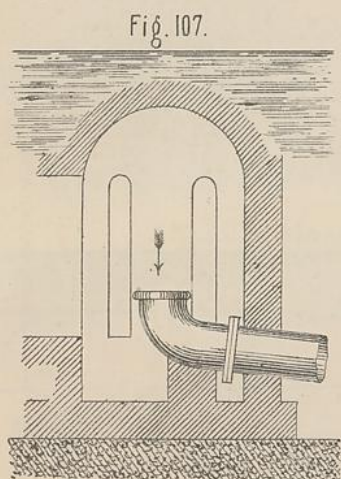
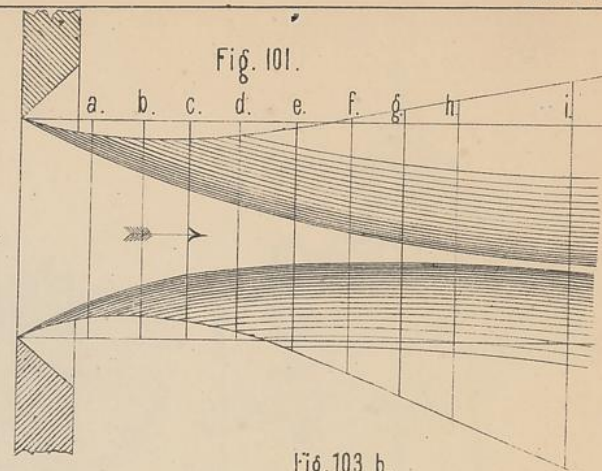
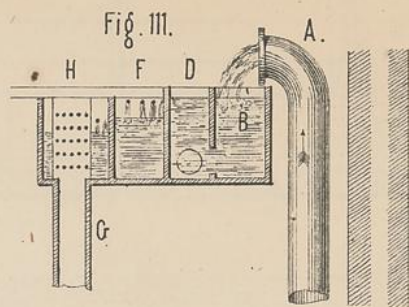
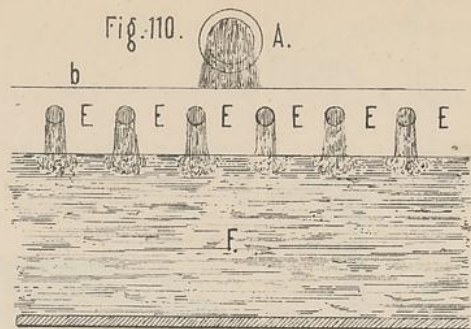
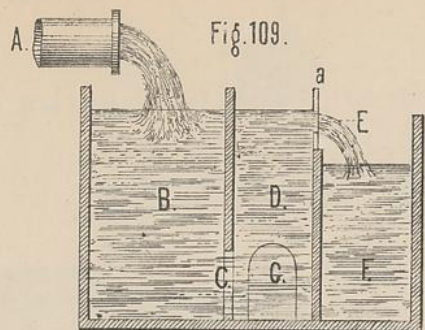

Fig. 102.

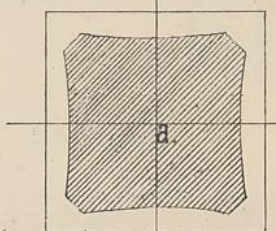

Fig. 103 a.

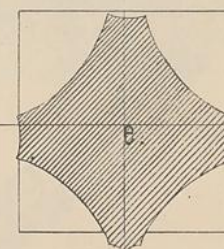

Fig. 103 b.

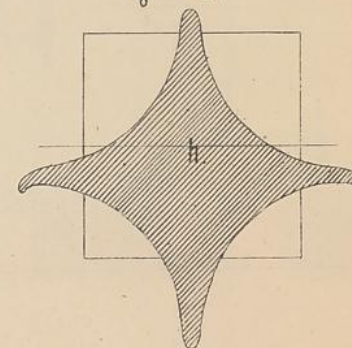

Fig. 104.

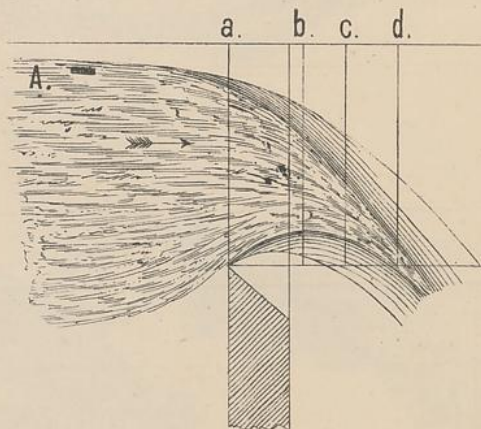

Fig. 105.

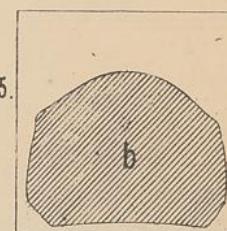

Fig. 105.

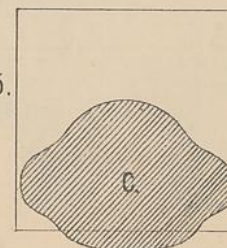
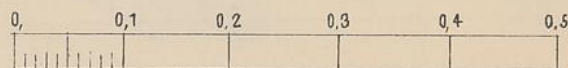
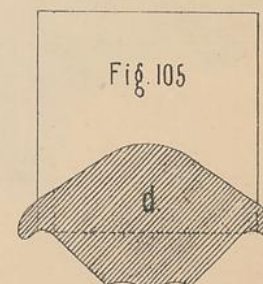
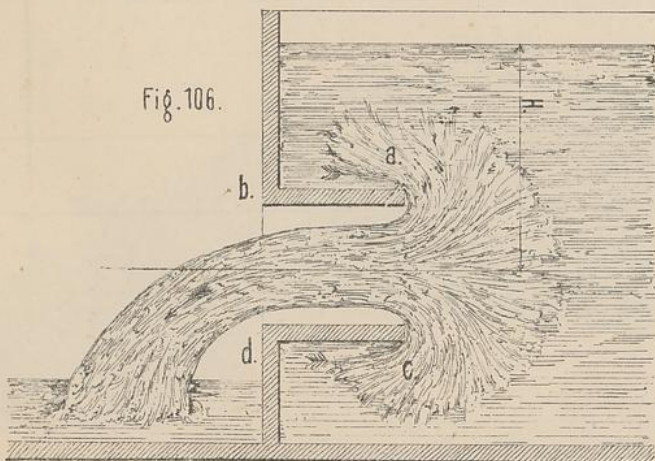

Fig. 105.



Mafsstab zu Fig. 102-105.

Fig. 106.



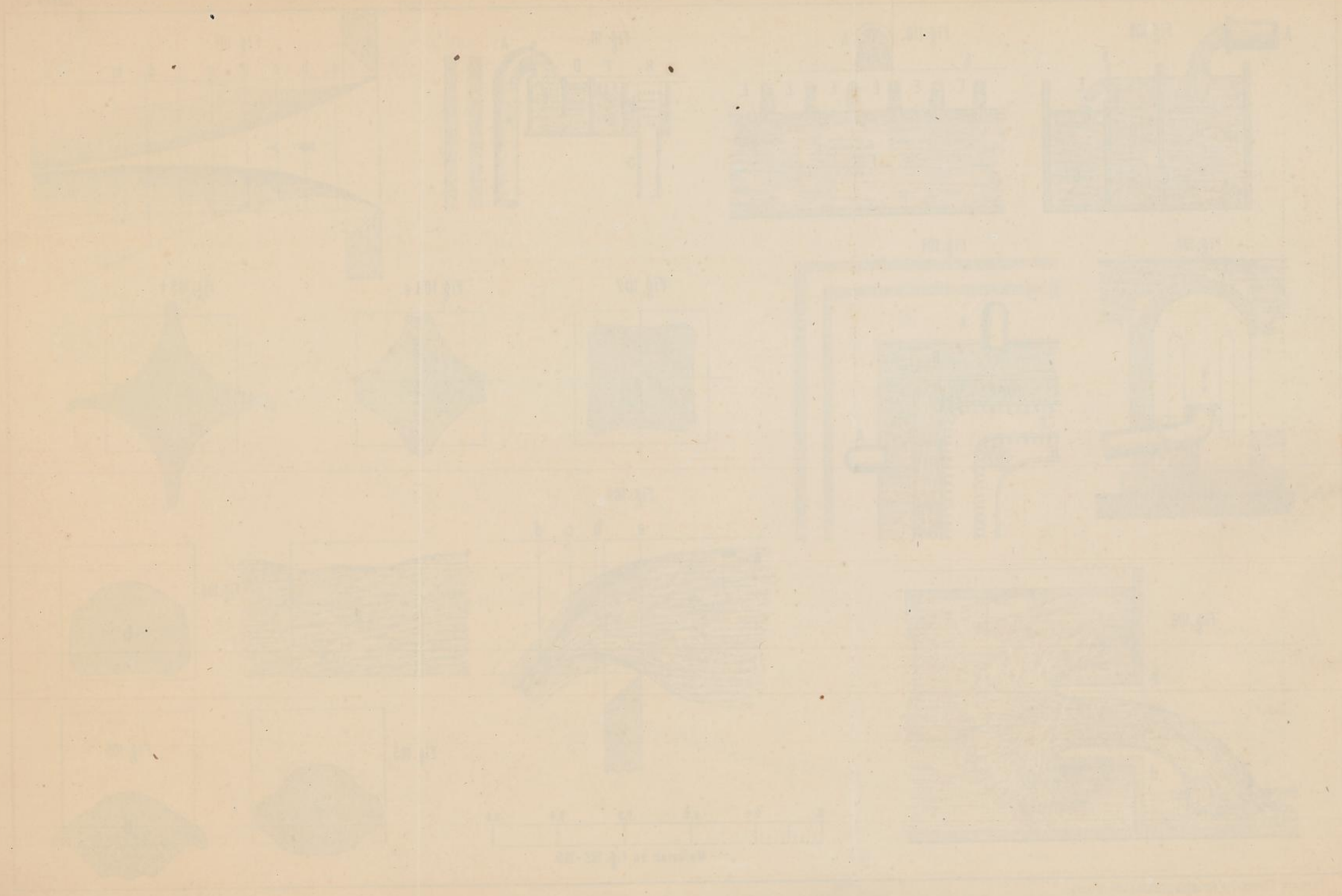
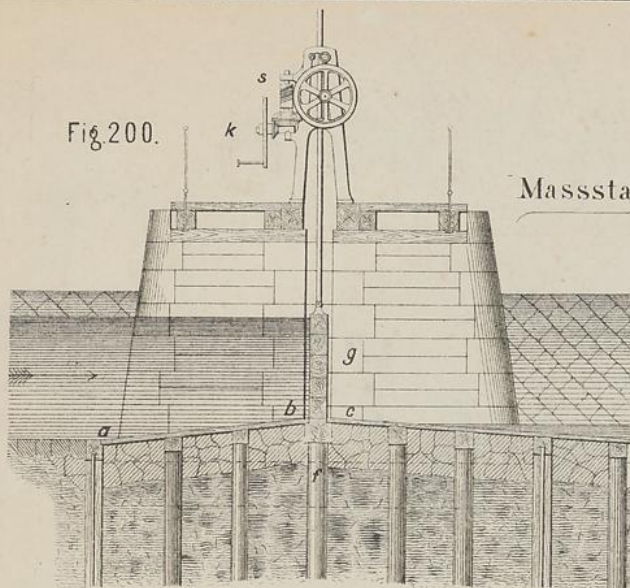

Fig.200.



Massstab = 1: 100.

Fig.201.

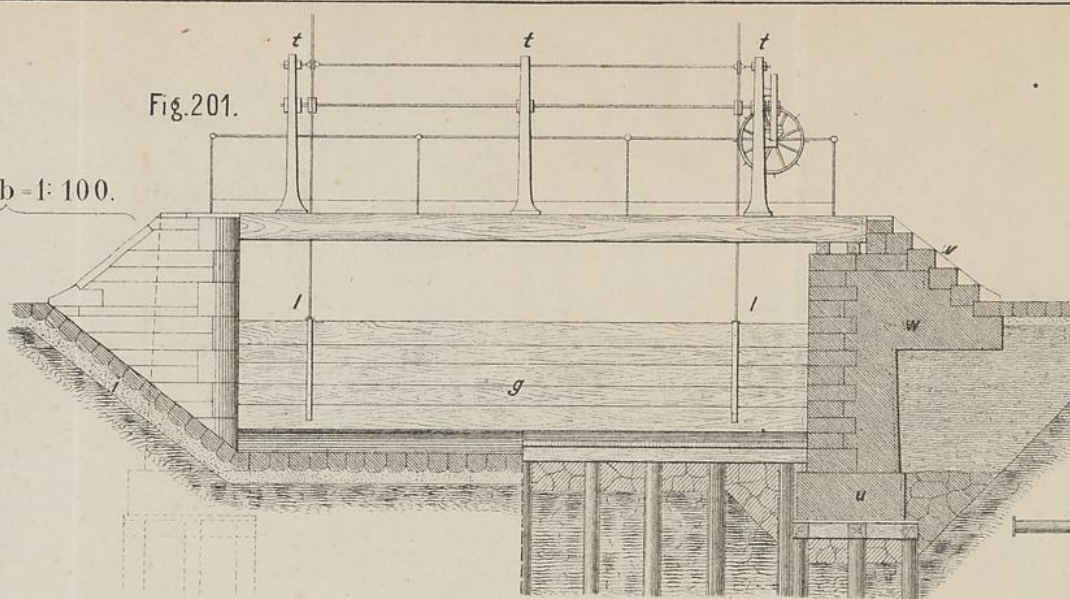

Fig.202.

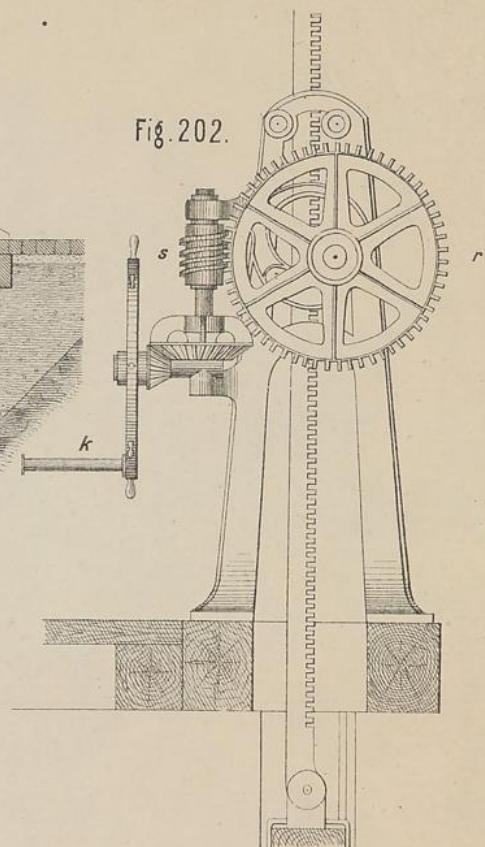

Fig.203. Massstab=1: 100.

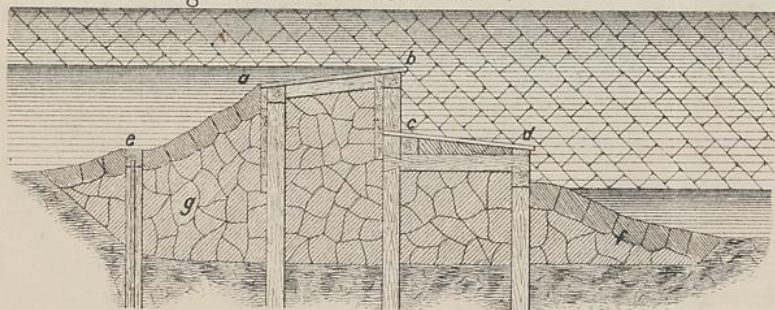

Fig.204.

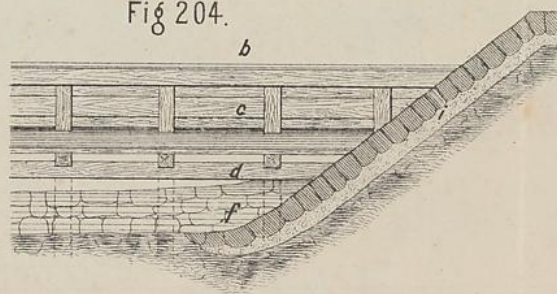

Fig.205.

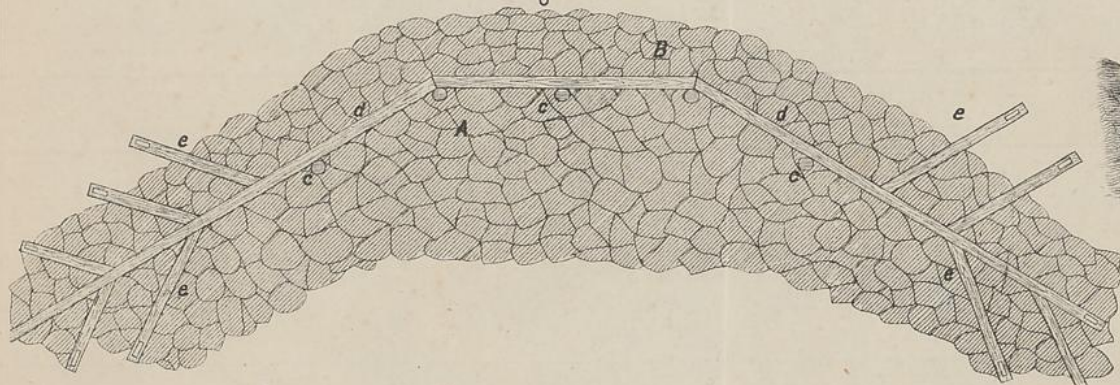
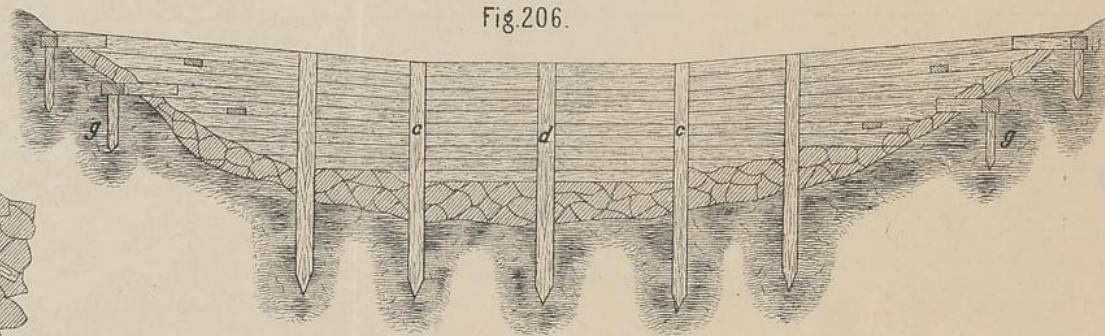
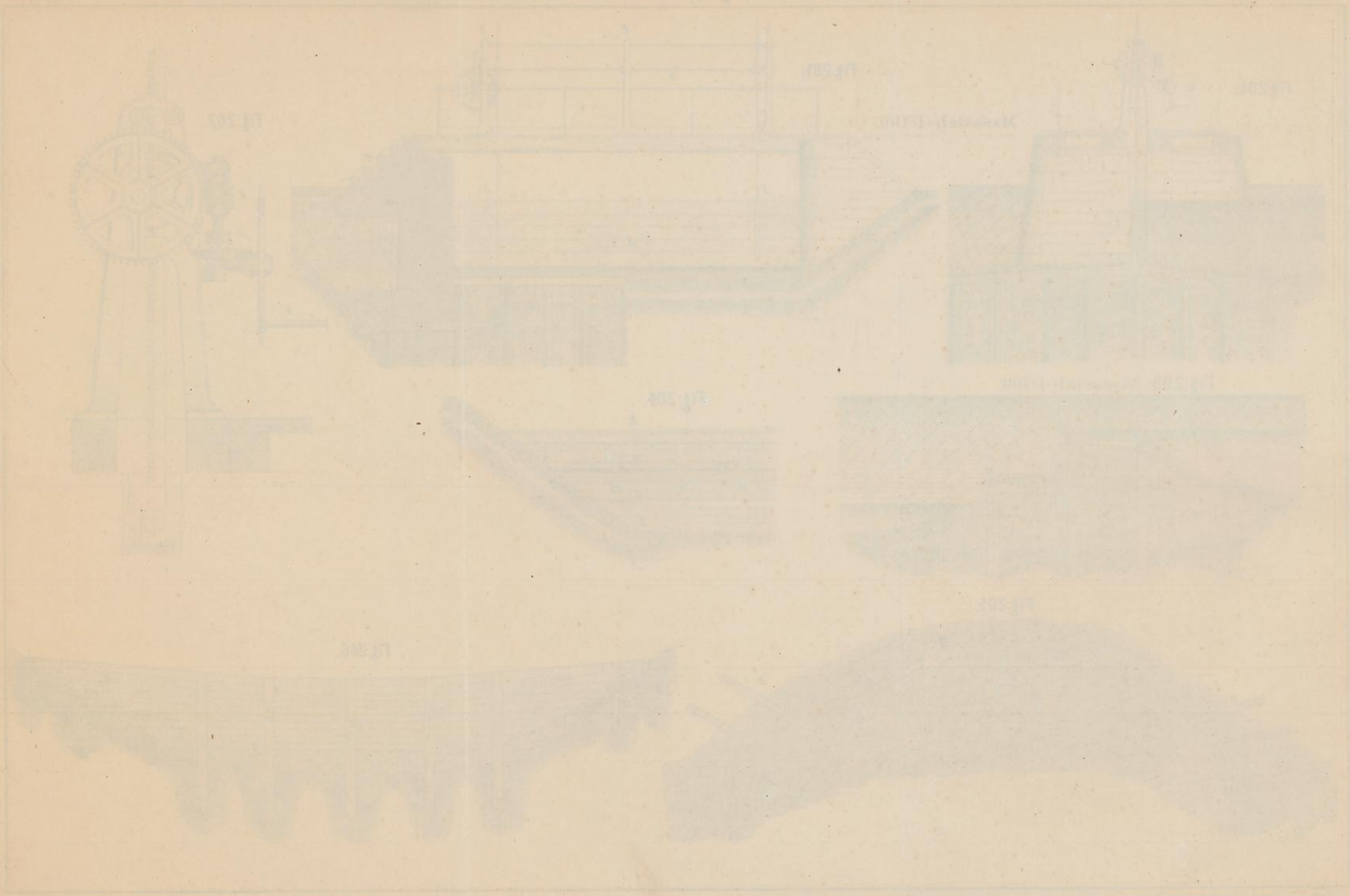

Fig.206.





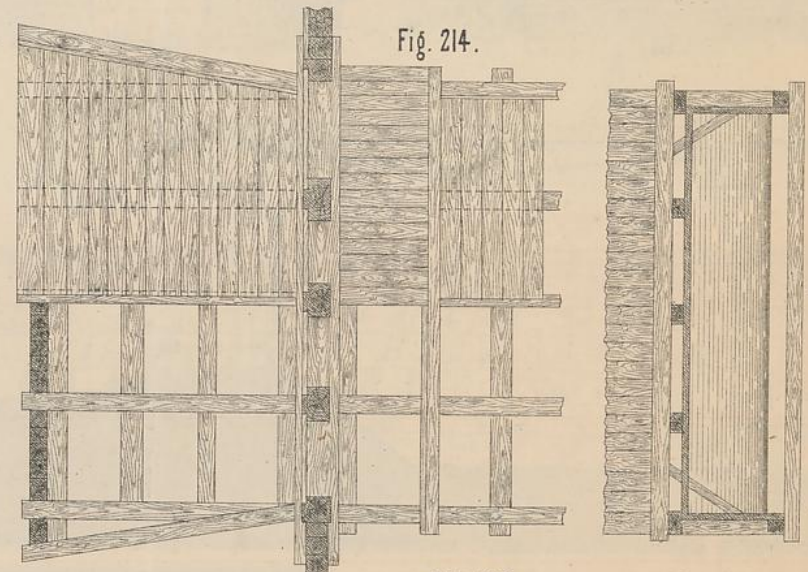
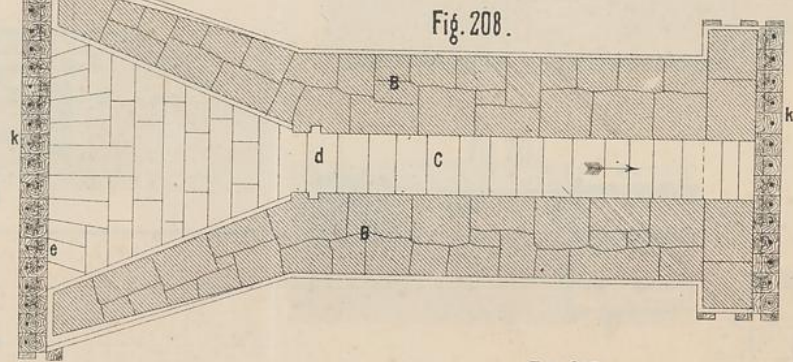
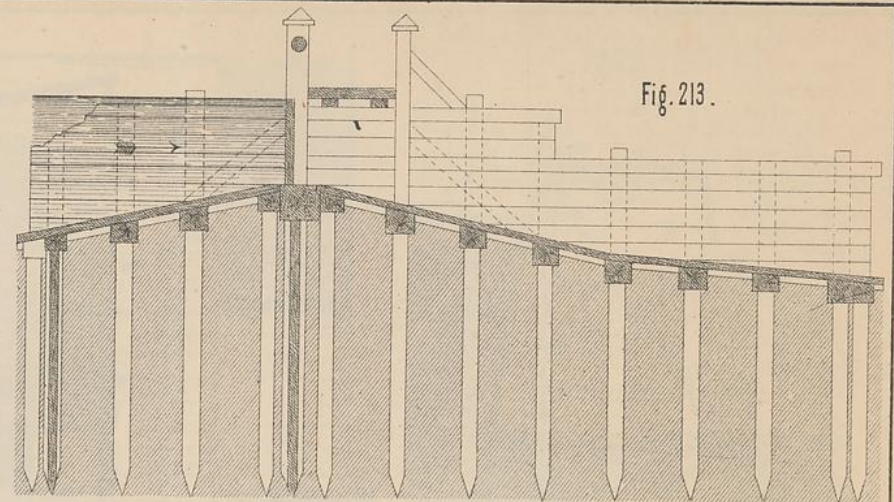
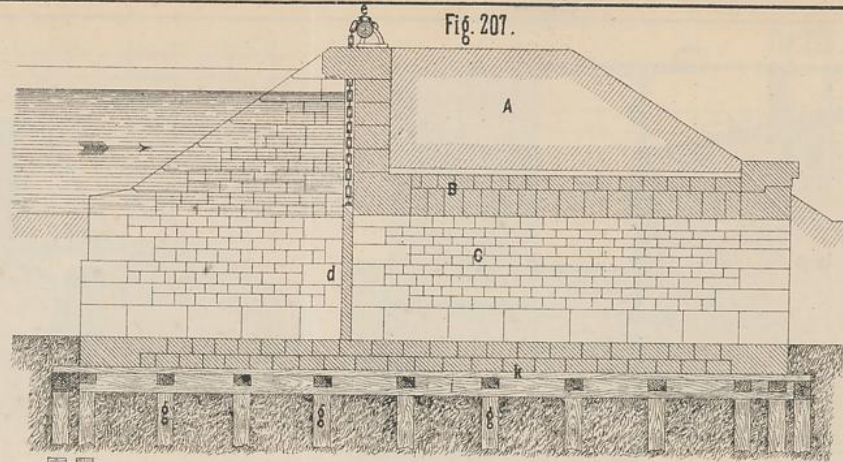
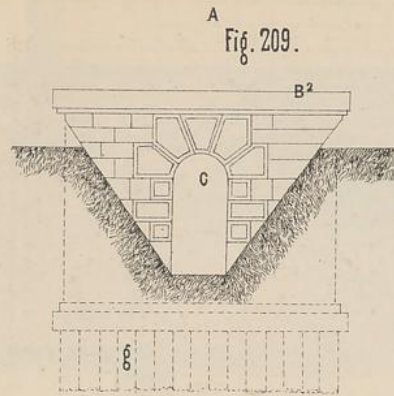
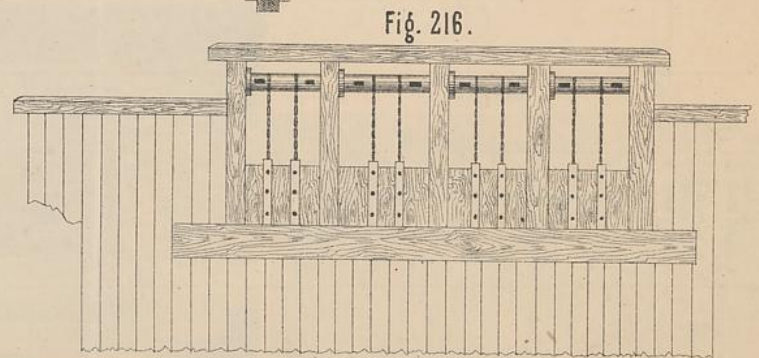
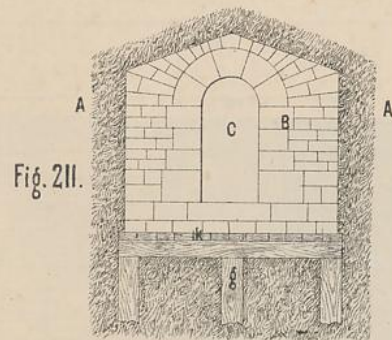
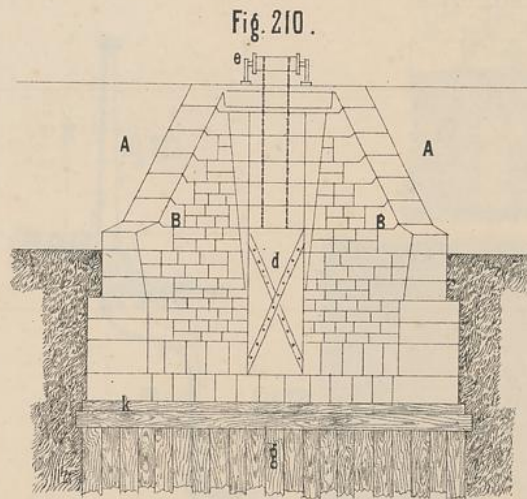
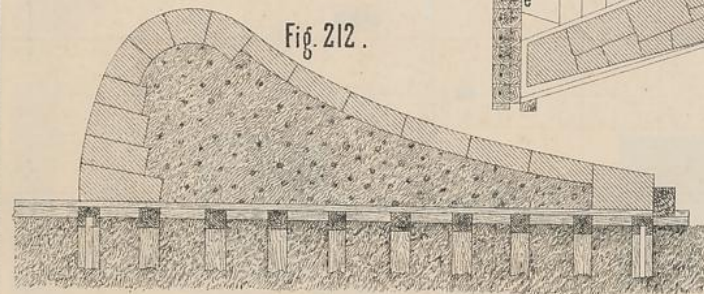
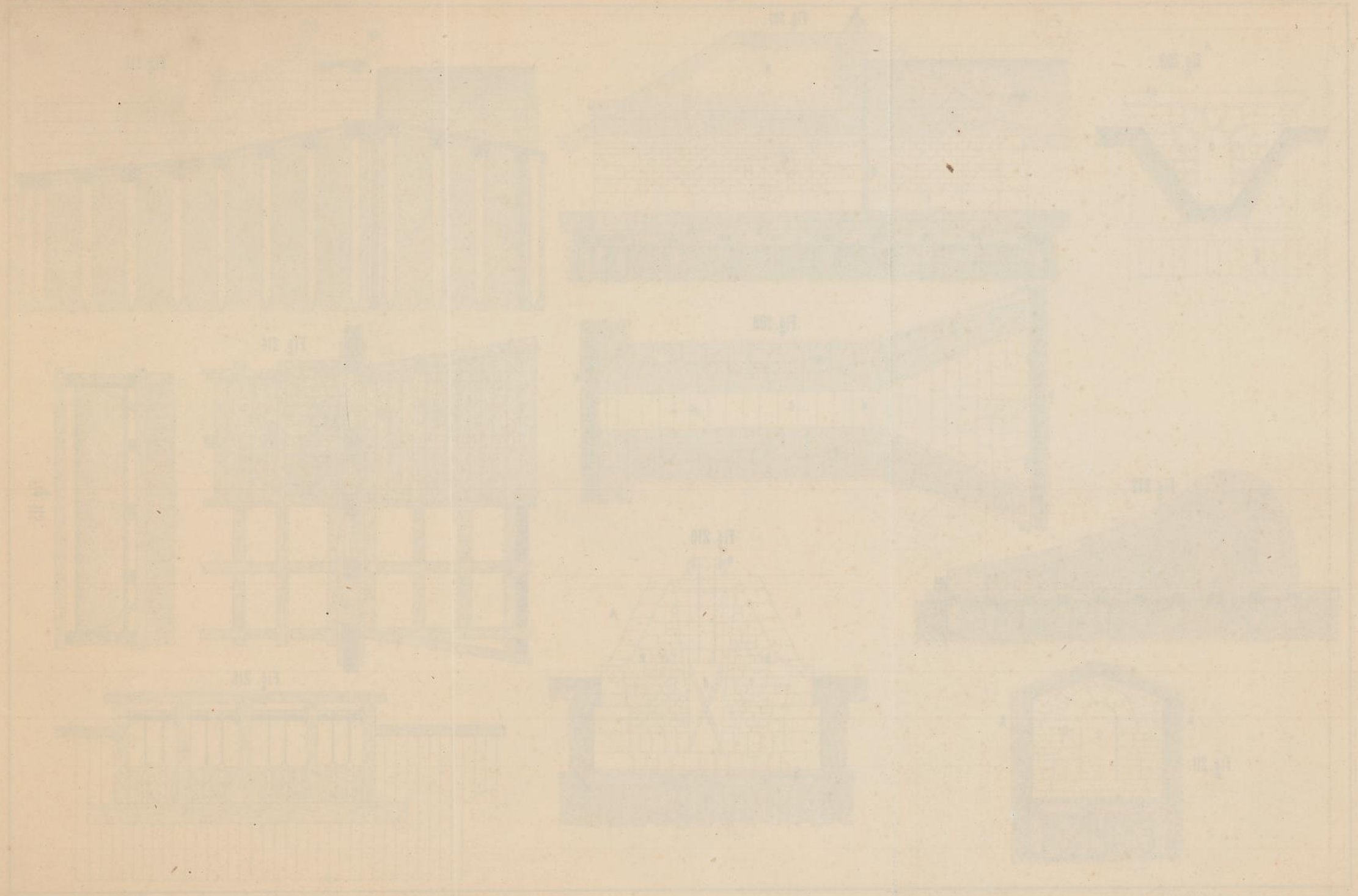
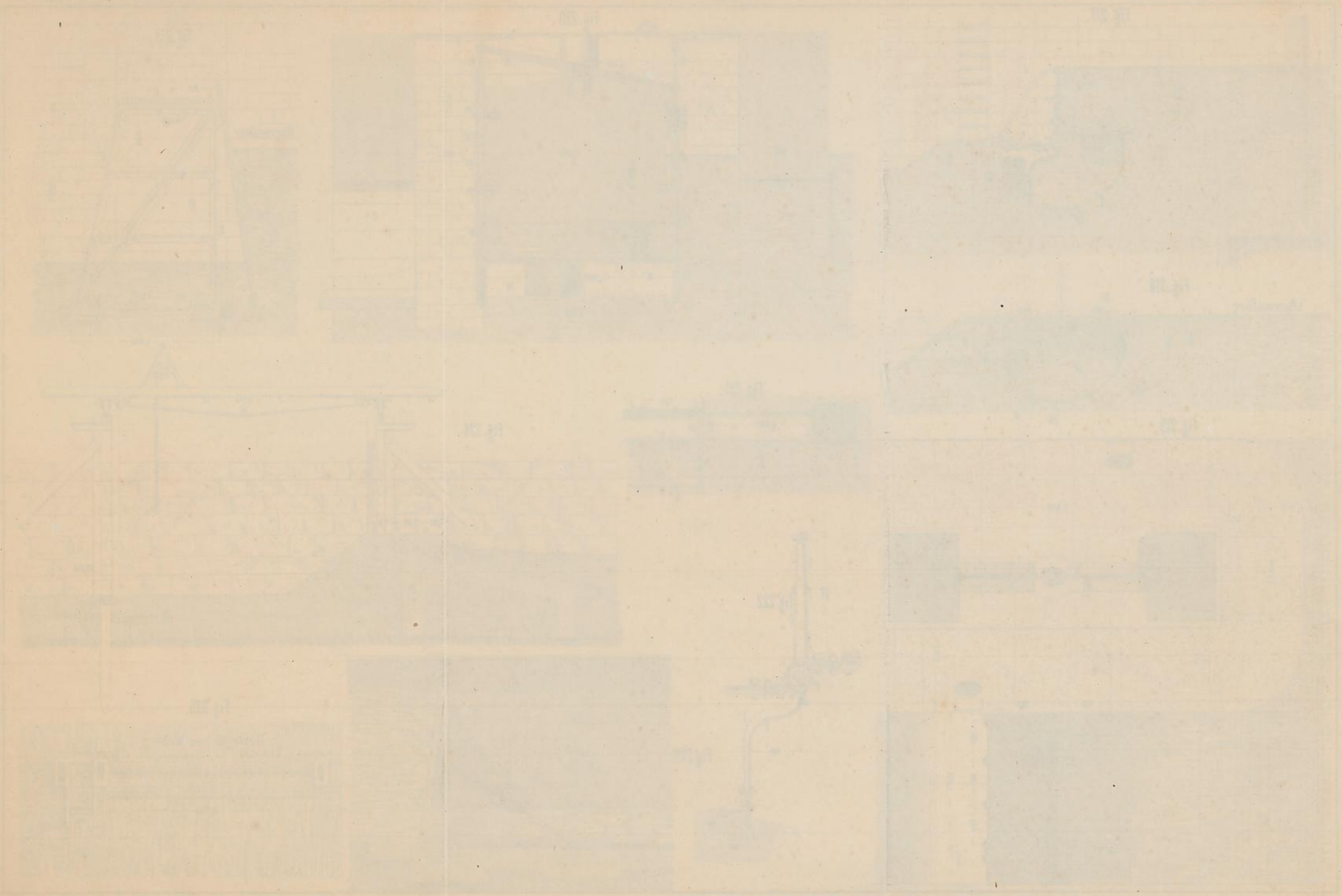

Fig. 115.







Bewegliche Wehre.

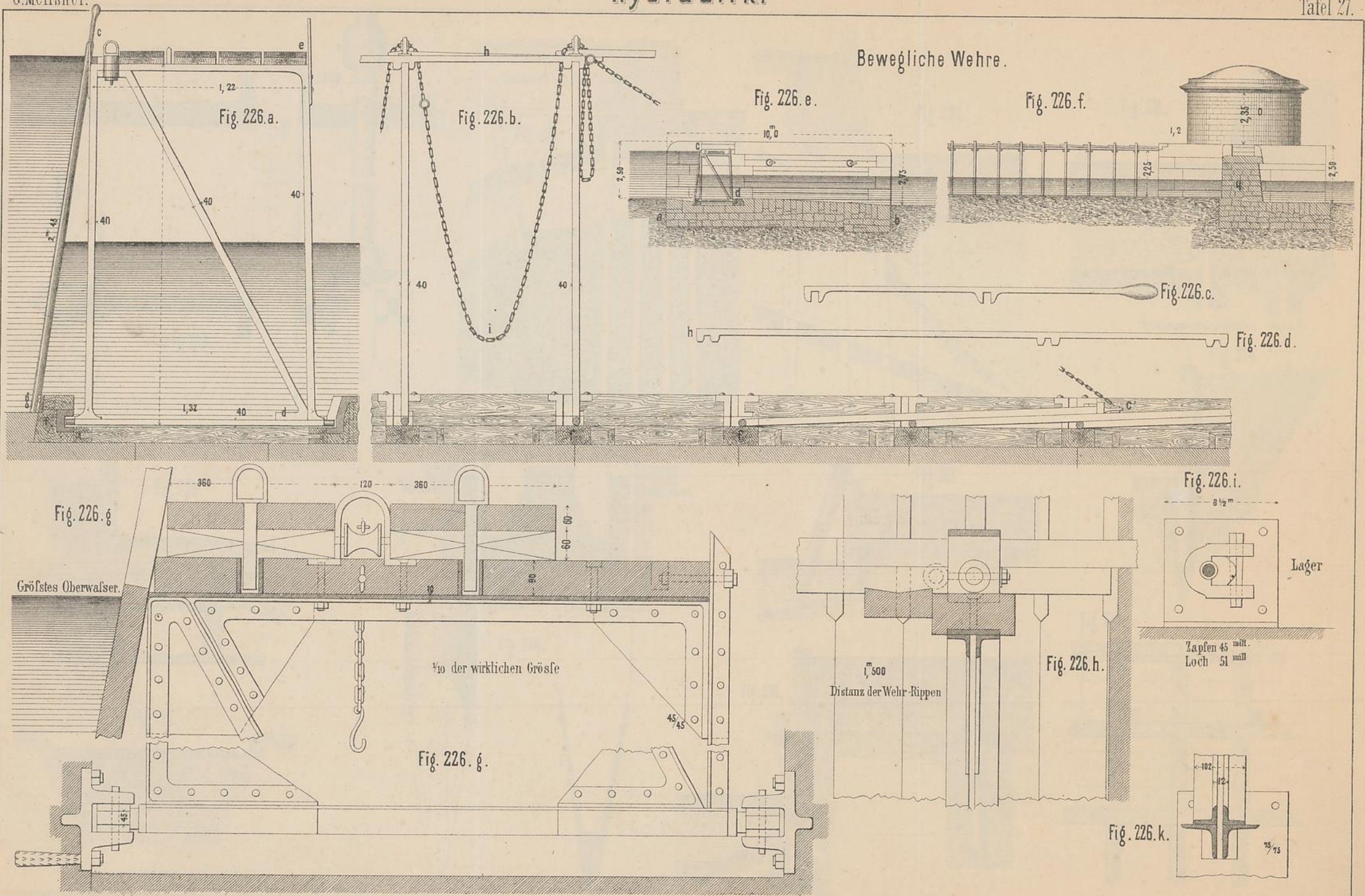

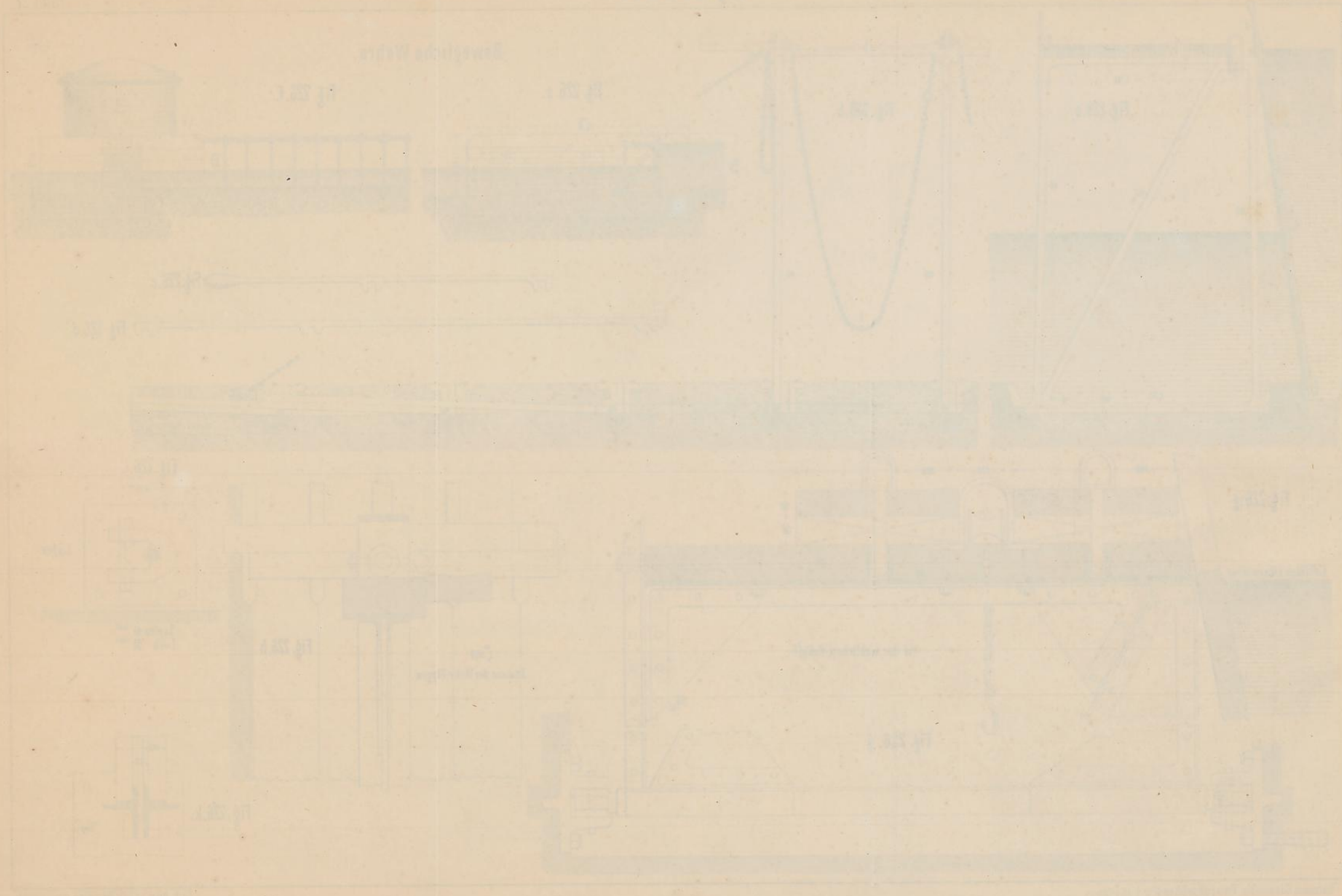

Einseitige Wehre

Fig. 1

Fig. 2

Fig. 3

Fig. 4

Fig. 5

Fig. 6

Fig. 7

Fig. 8

Fig. 9

Fig. 10

Fig. 11

Fig. 12

Fig. 13

Fig. 14

Fig. 15

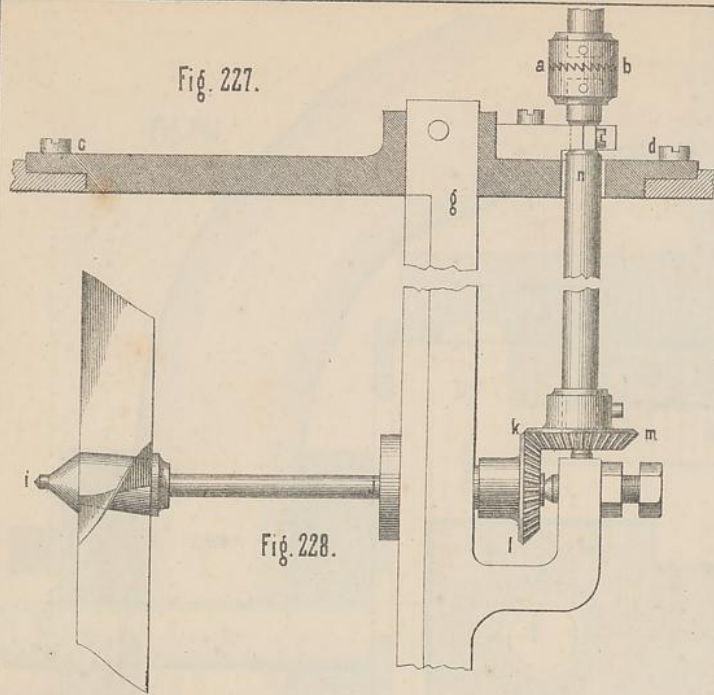

Fig. 227.

Fig. 228.

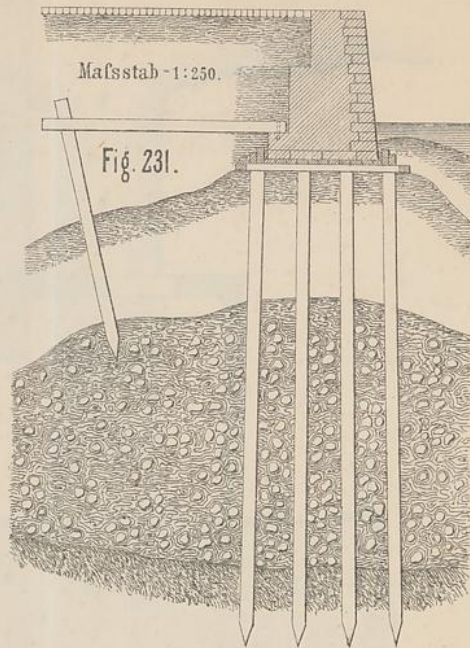

Fig. 231.

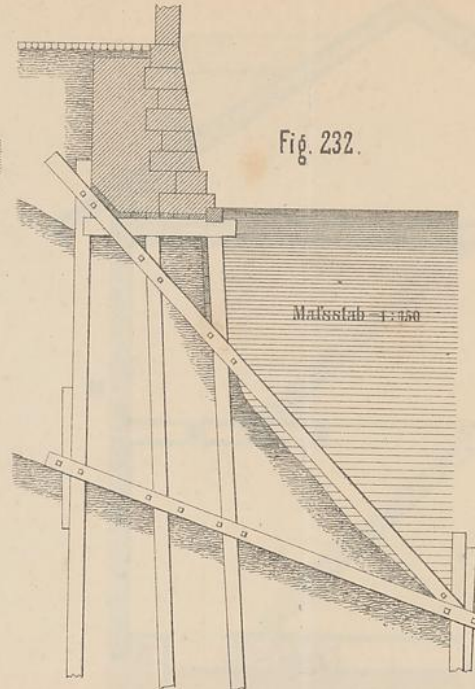

Fig. 232.

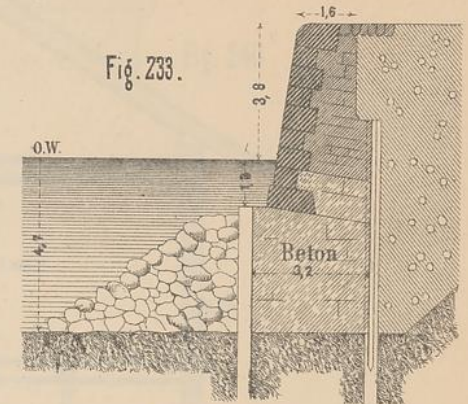

Fig. 233.

Quaimauer der Donau. 1/200 n.Gr.

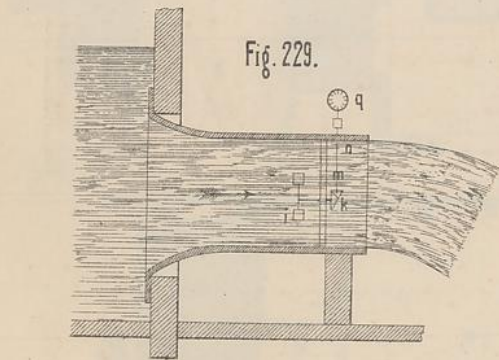

Fig. 229.

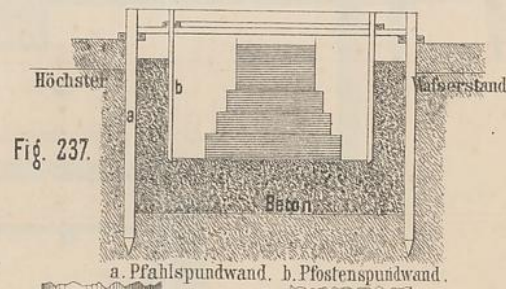

Fig. 237.

a. Pfahlsplundwand, b. Pfostensplundwand.

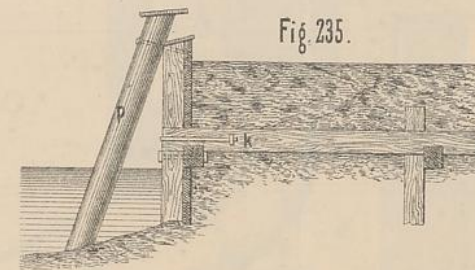

Fig. 235.

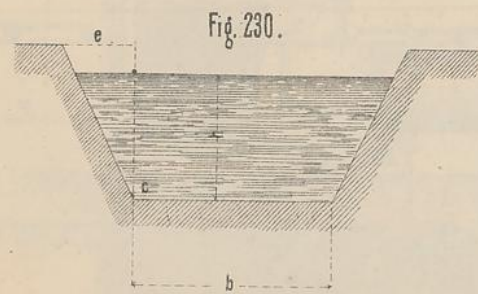

Fig. 230.

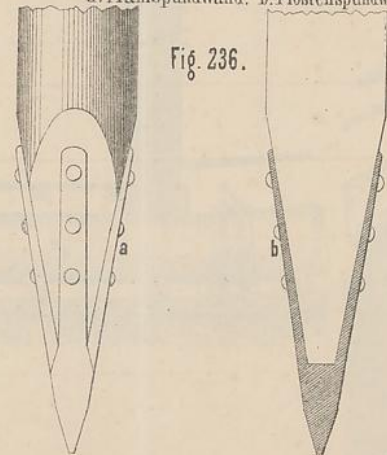

Fig. 236.

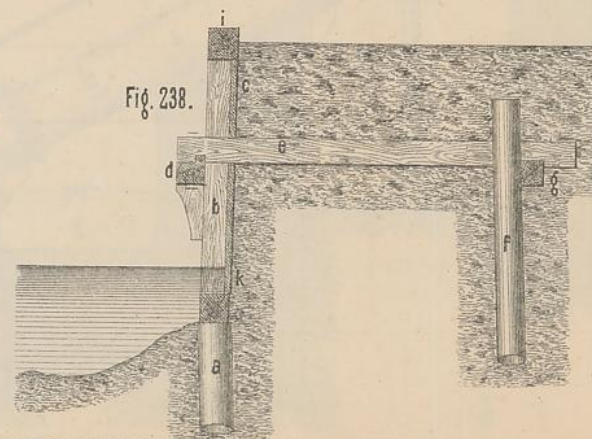

Fig. 238.

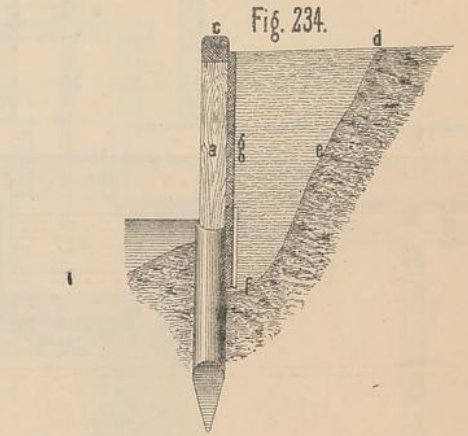

Fig. 234.

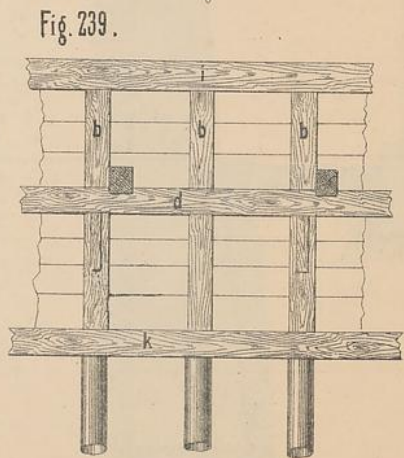
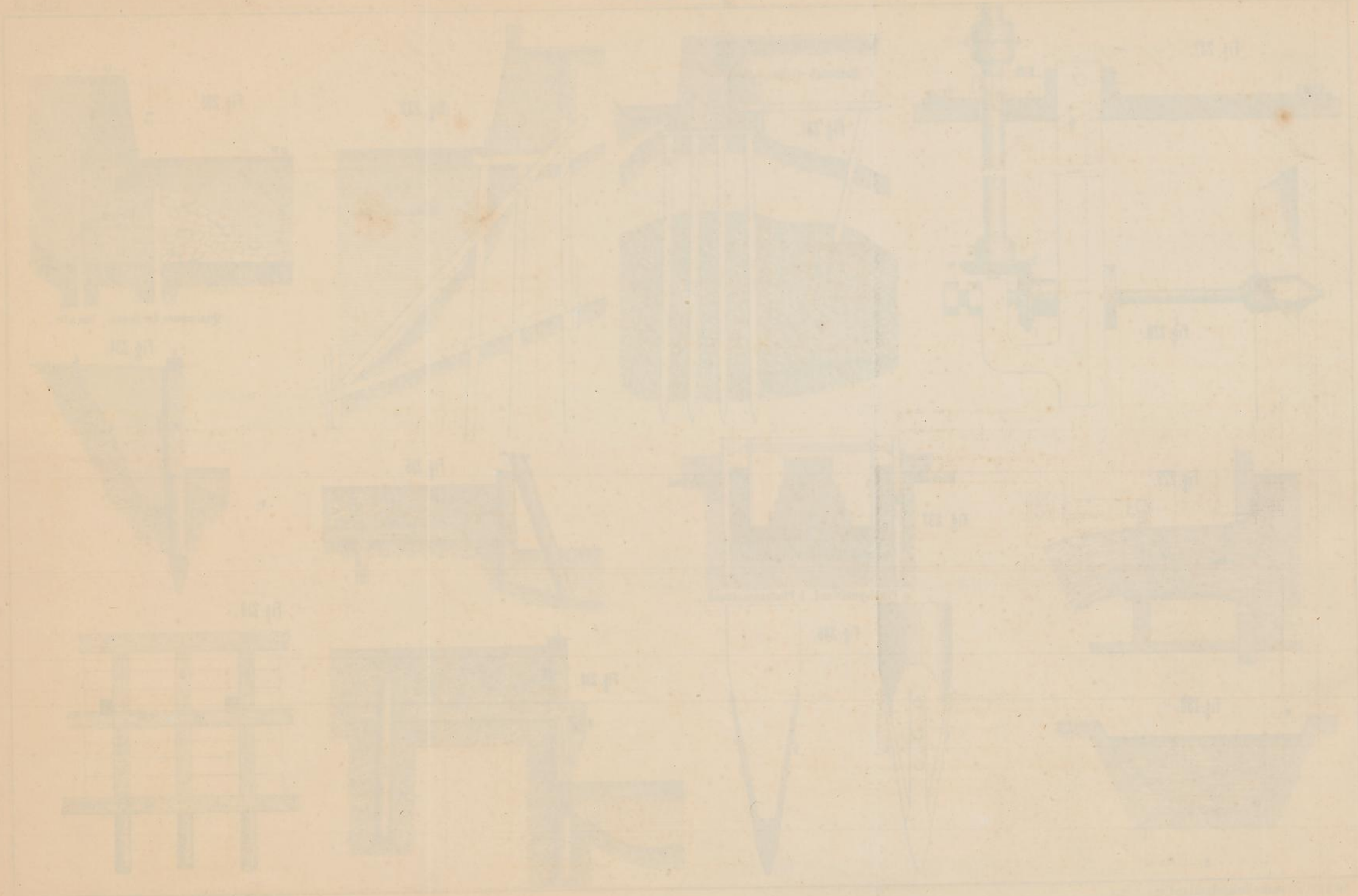
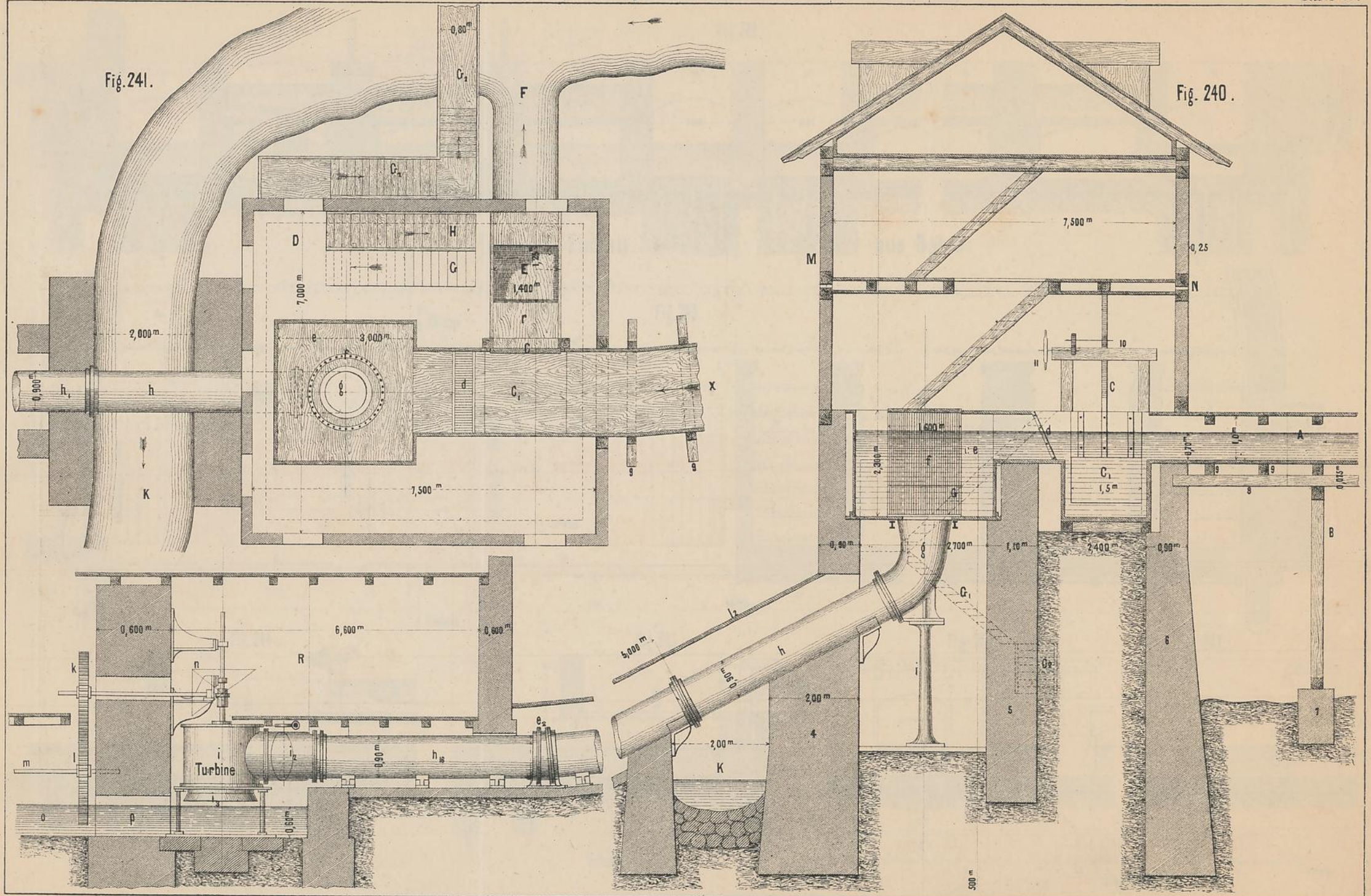

Fig. 239.





Hermann Costenoble, Verlagsbuchhandlung in Jena

Turbinen-Anlage am Pissvache (Wallis, Schweiz.)
Fassung u. Leitung des Wassers.

Lith. Anst. v. J.G. Fritzsche in Leipzig.

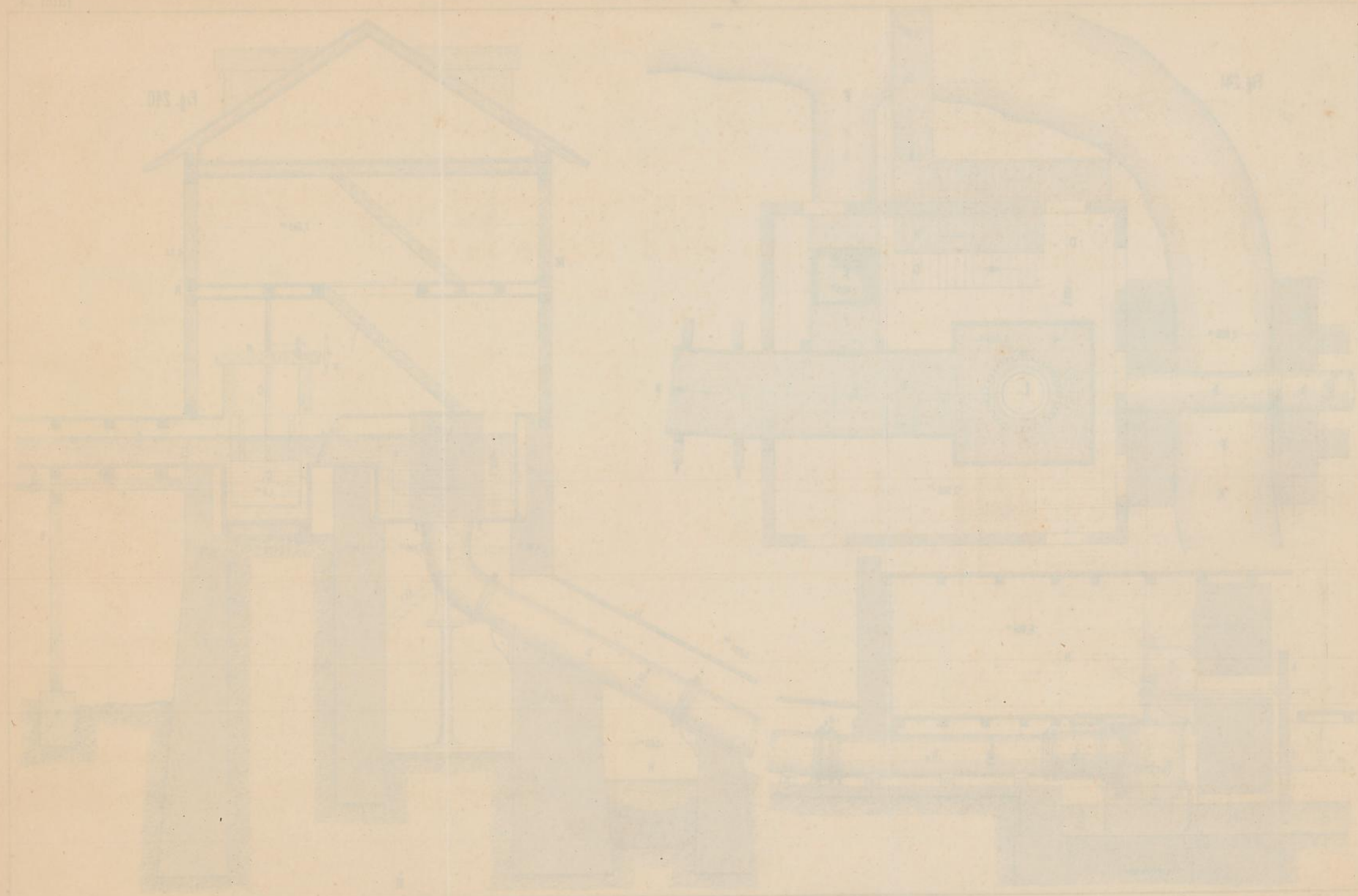

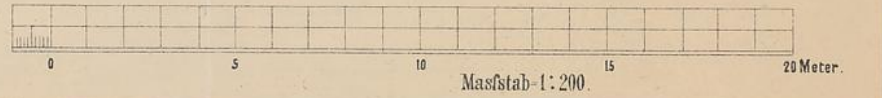
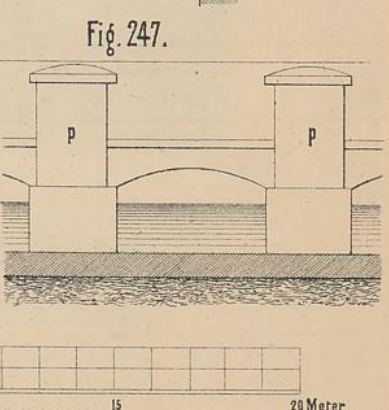
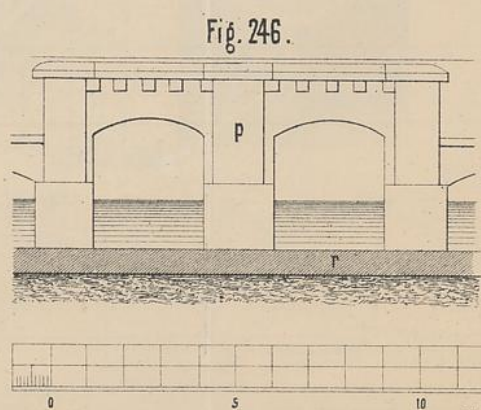
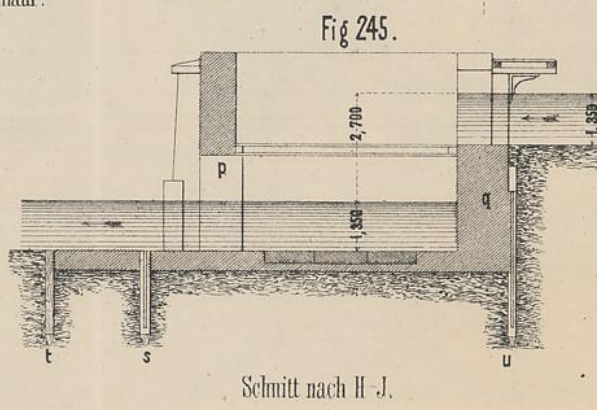
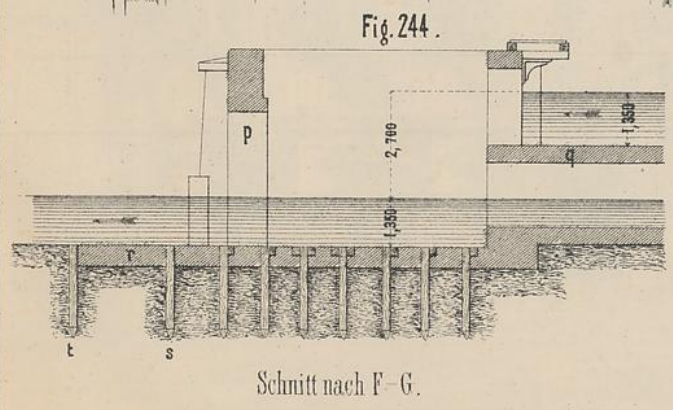
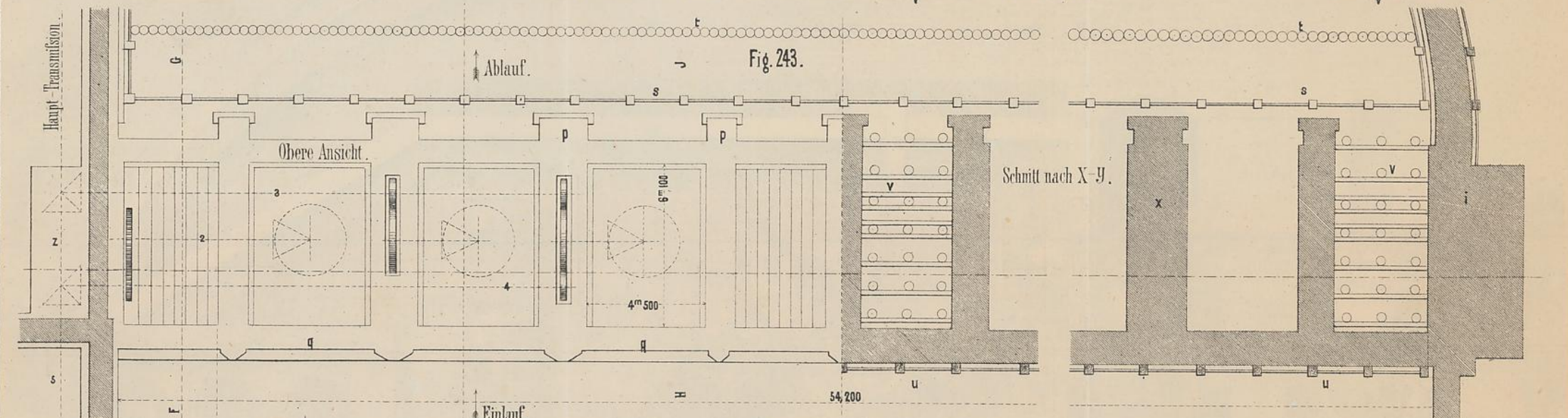
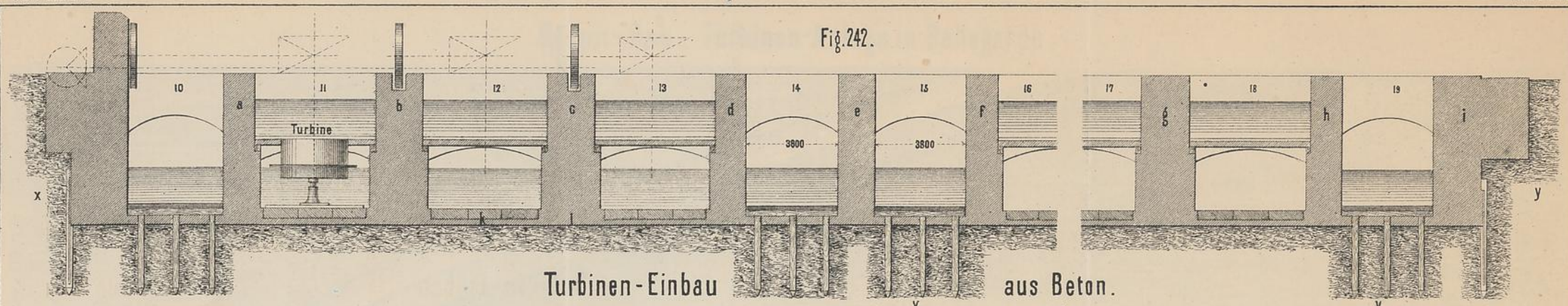

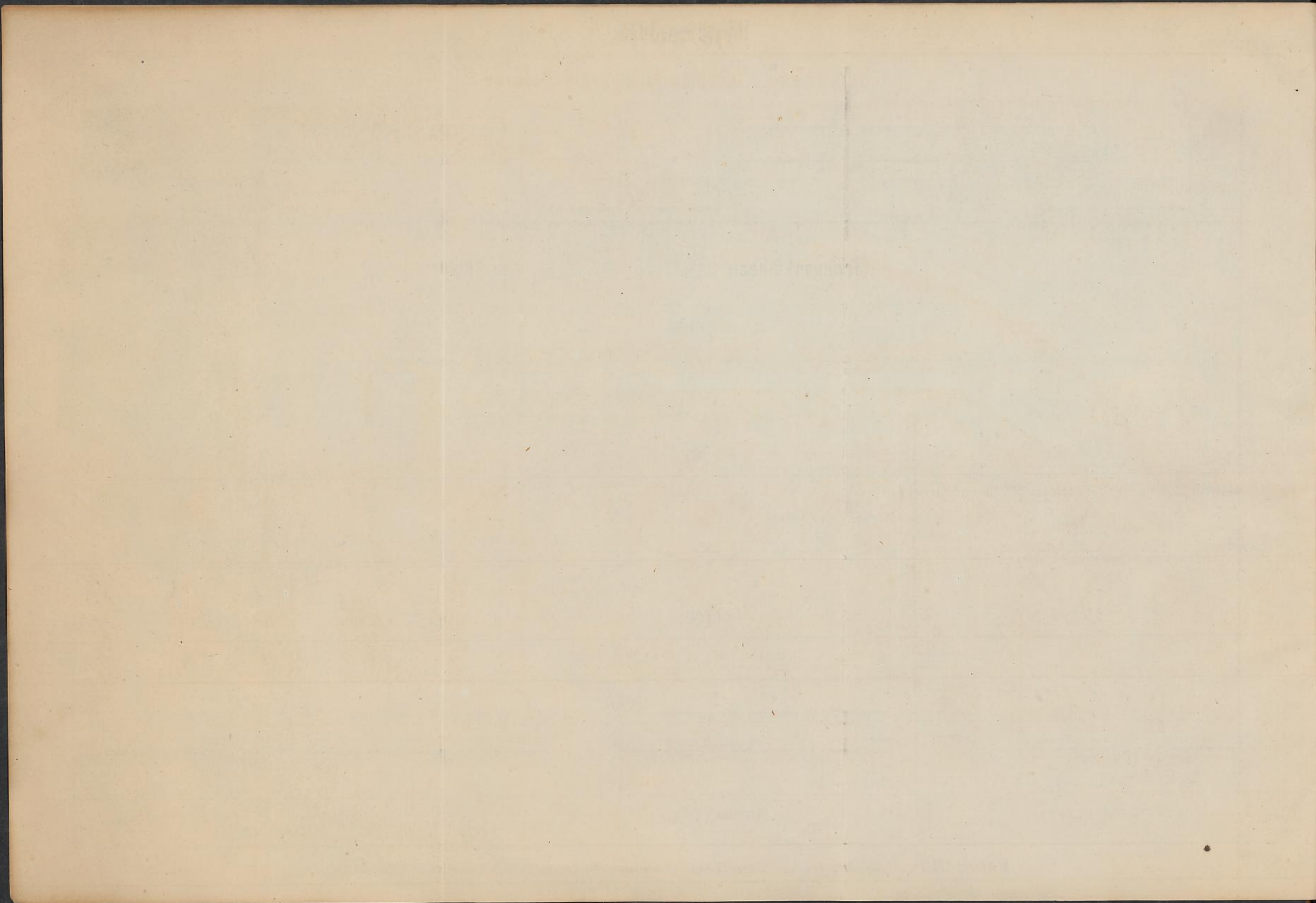

Beton-Bau . Turbinen-Anlage in Bellegarde.

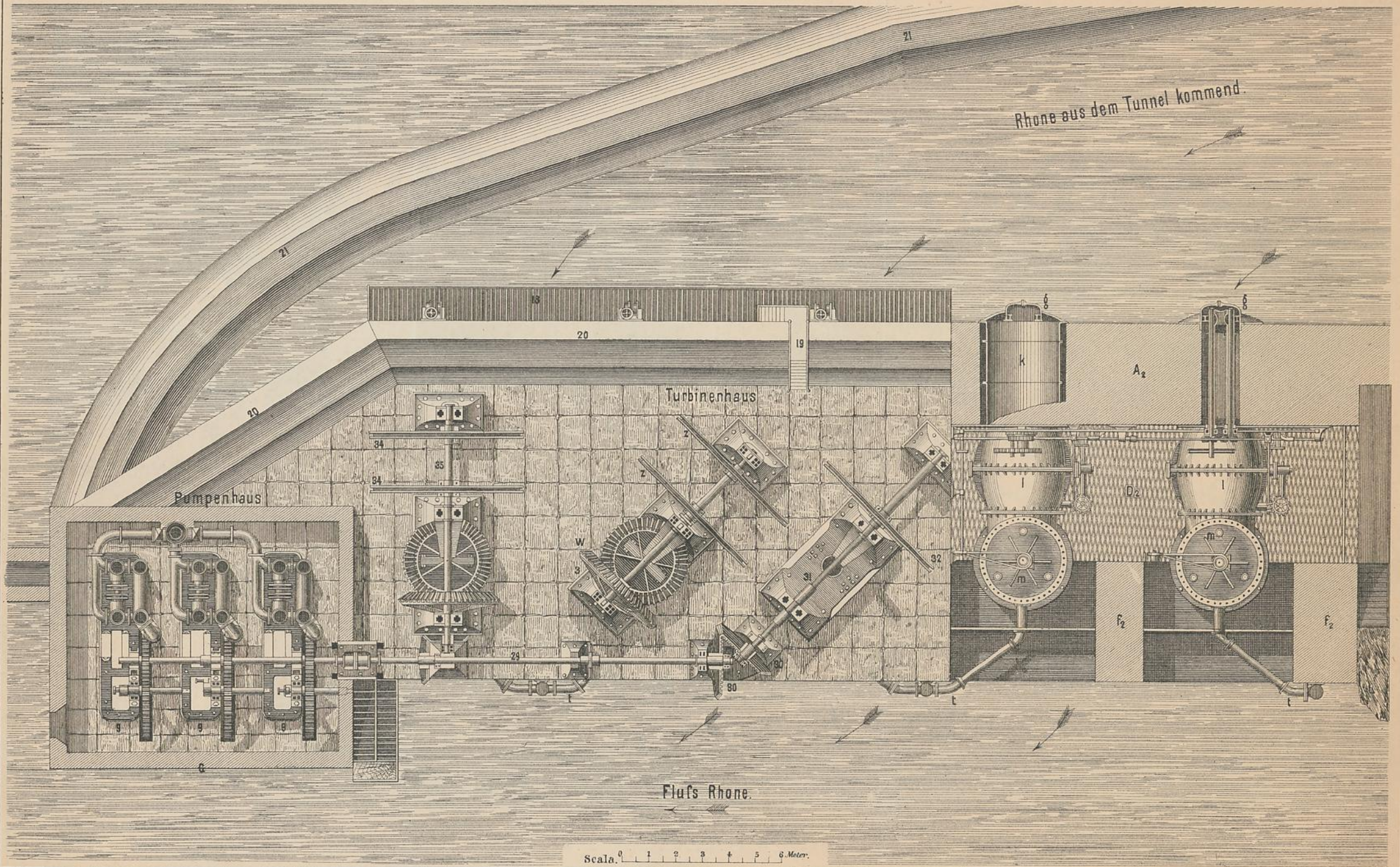

1875

Baton Rouge, Louisiana, August 10, 1875

Dear Sir,

I have the honor to acknowledge the receipt of your letter of the 7th inst. in relation to the matter of the purchase of land for the proposed canal. I am sorry to hear that you are not satisfied with the plan proposed. I have no objection to your making such changes as you may think proper, provided they do not materially increase the cost of the work. I am, Sir, very respectfully,
Yours truly,
J. M. [Name]

Beton-Bau. Turbinen-Anlage in Bellegarde.

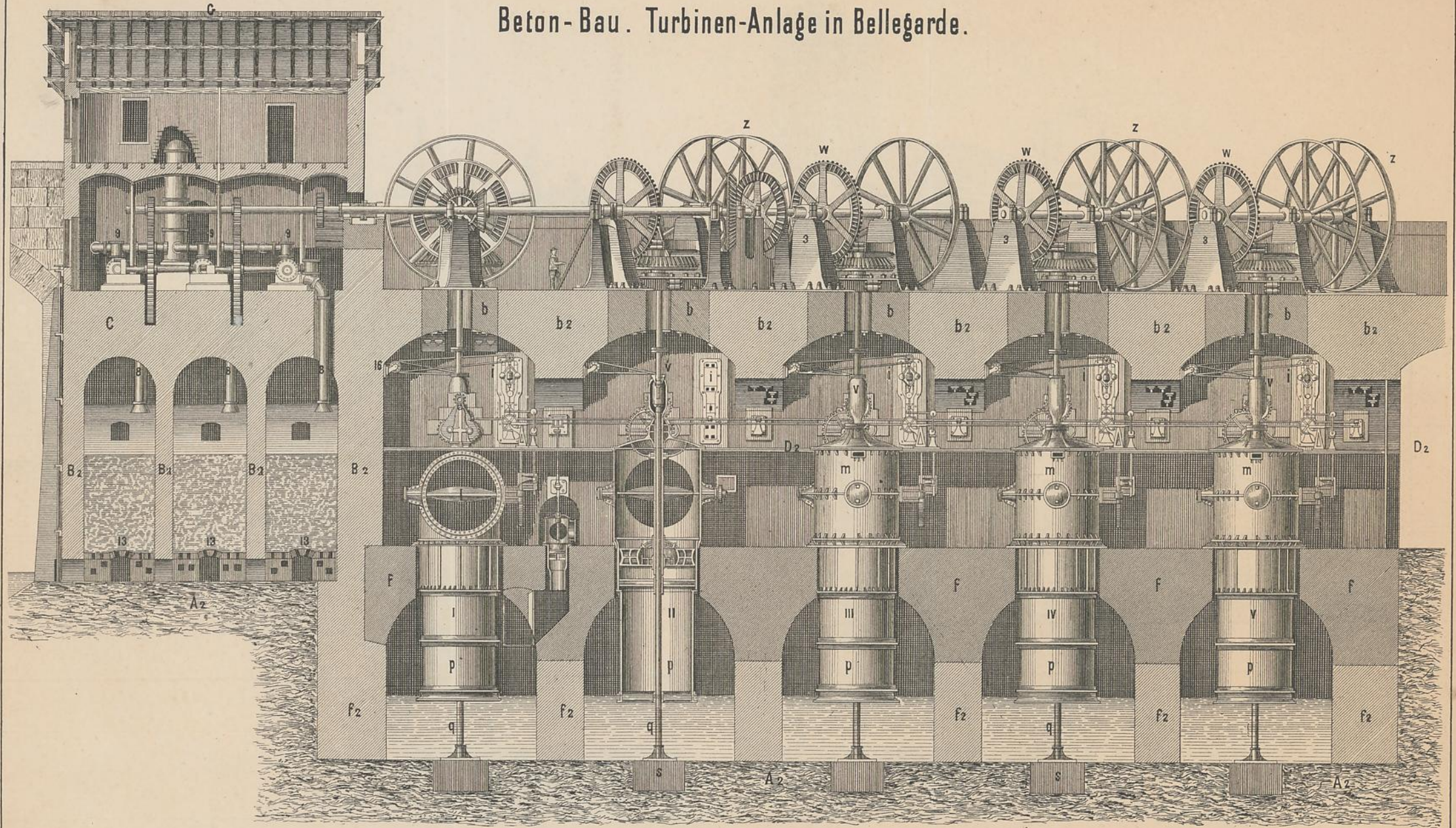

0 1 2 3 4 5 6 Meter.

1870

John Doe, Esq. New York

Faint, illegible text, possibly bleed-through from the reverse side of the page.

1871

John - Geo. Johnson - 1871

Year	John	Geo.
1871		
1872		
1873		
1874		
1875		
1876		
1877		
1878		
1879		
1880		
1881		
1882		
1883		
1884		
1885		
1886		
1887		
1888		
1889		
1890		
1891		
1892		
1893		
1894		
1895		
1896		
1897		
1898		
1899		
1900		

Fig. 248.

Girard'sche Pumpe für Wasserversorgungen.

$\frac{1}{20}$ der wirklichen Größe.

Fig. 249.

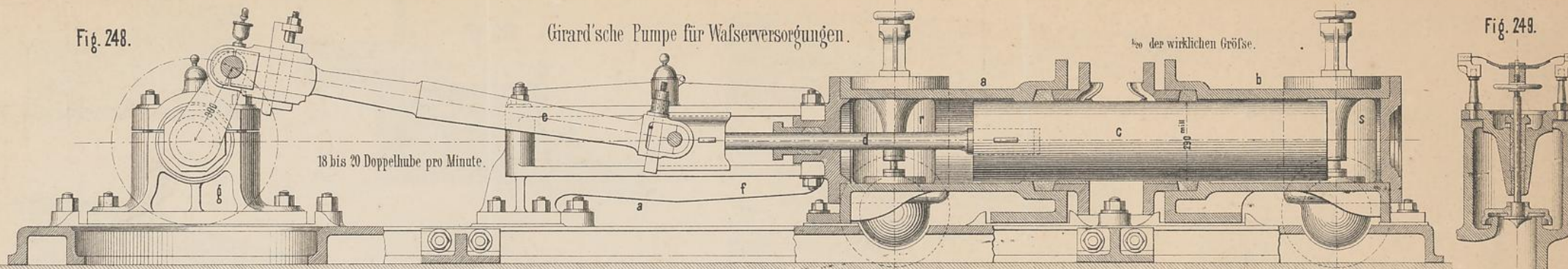

18 bis 20 Doppelhube pro Minute.

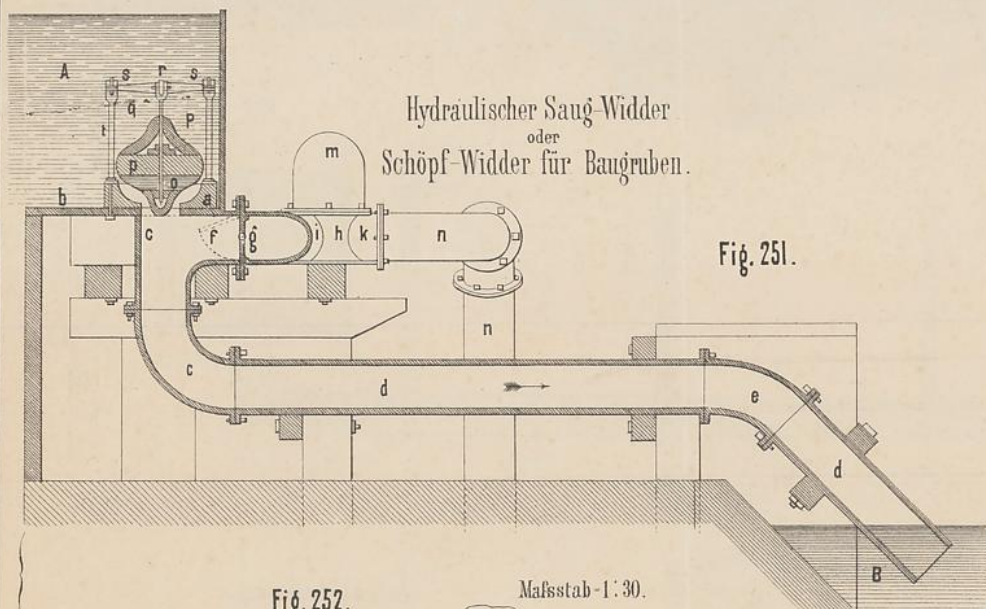

Hydraulischer Saug-Widder
oder
Schöpf-Widder für Baugruben.

Fig. 251.

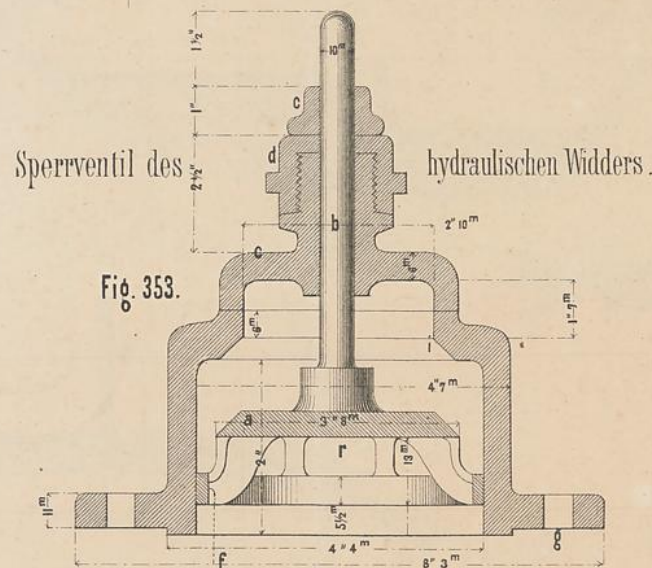

Sperrventil des hydraulischen Widders.

Fig. 353.

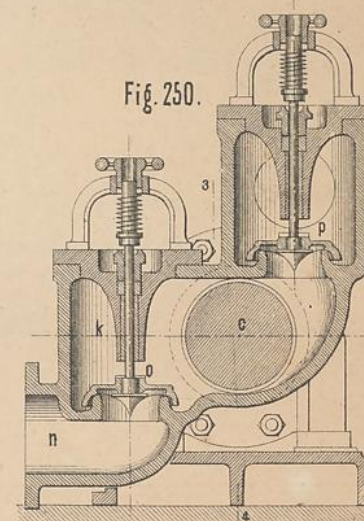

Fig. 250.

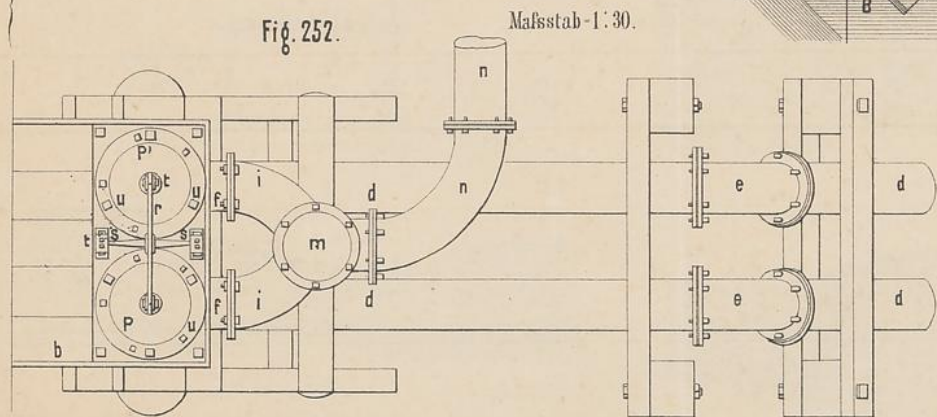
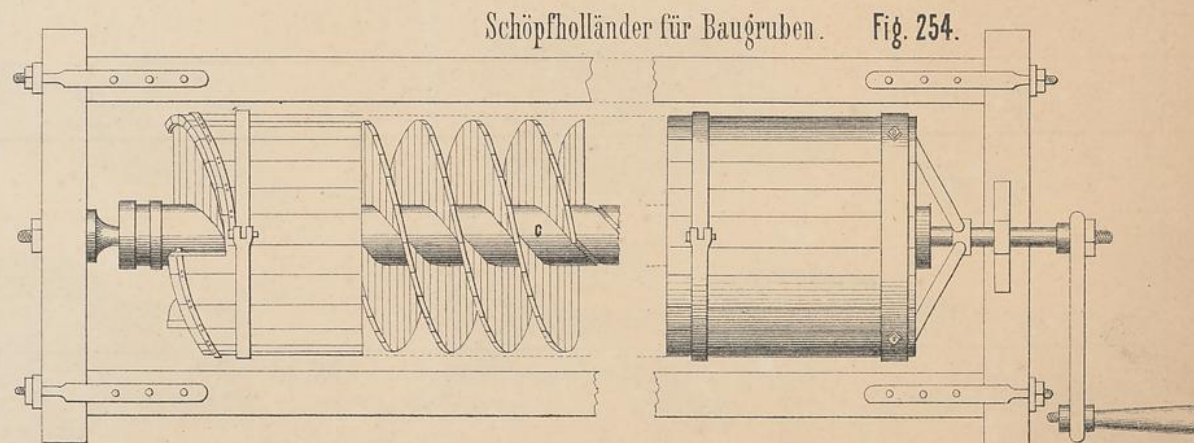
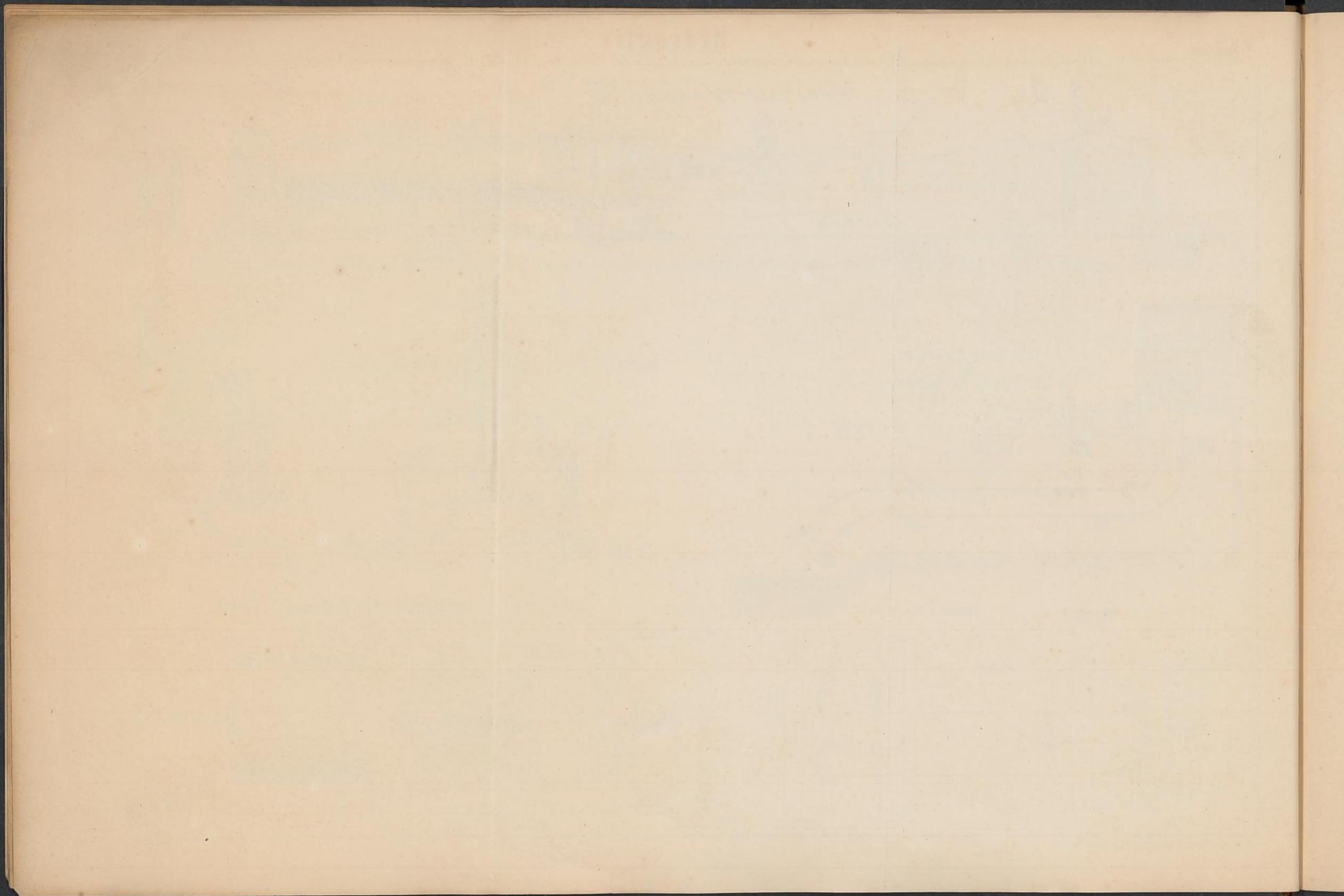

Fig. 252.

Masstab 1:30.



Schöpholländer für Baugruben. Fig. 254.



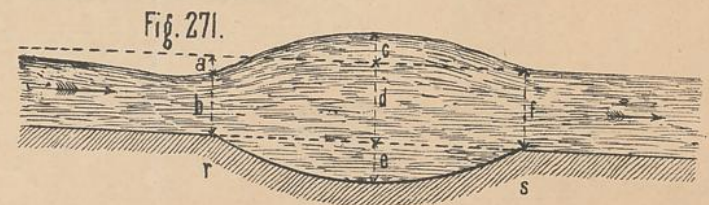
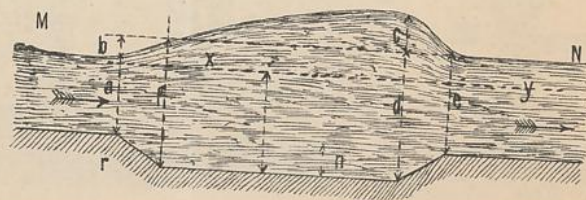
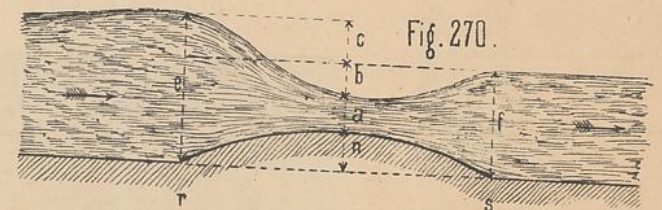
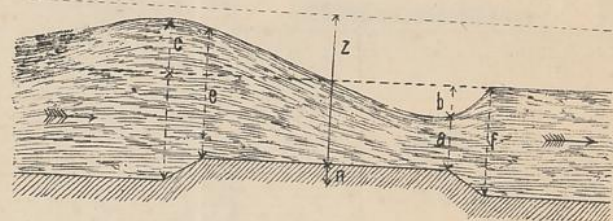
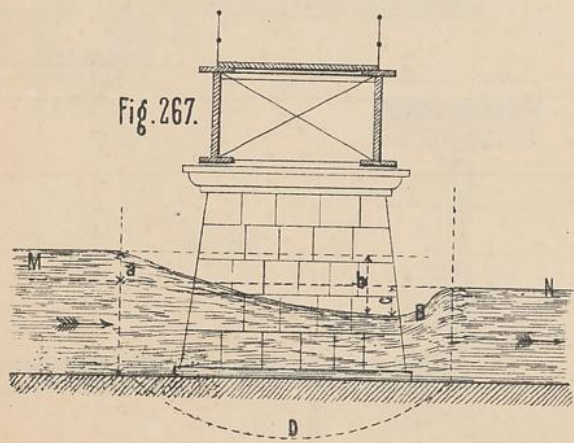
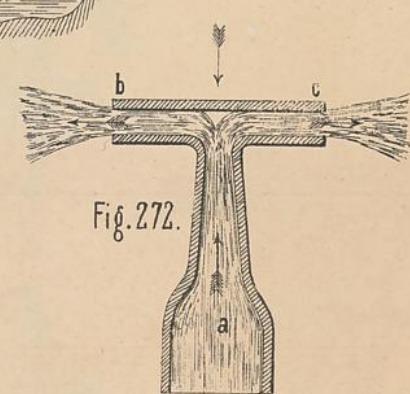
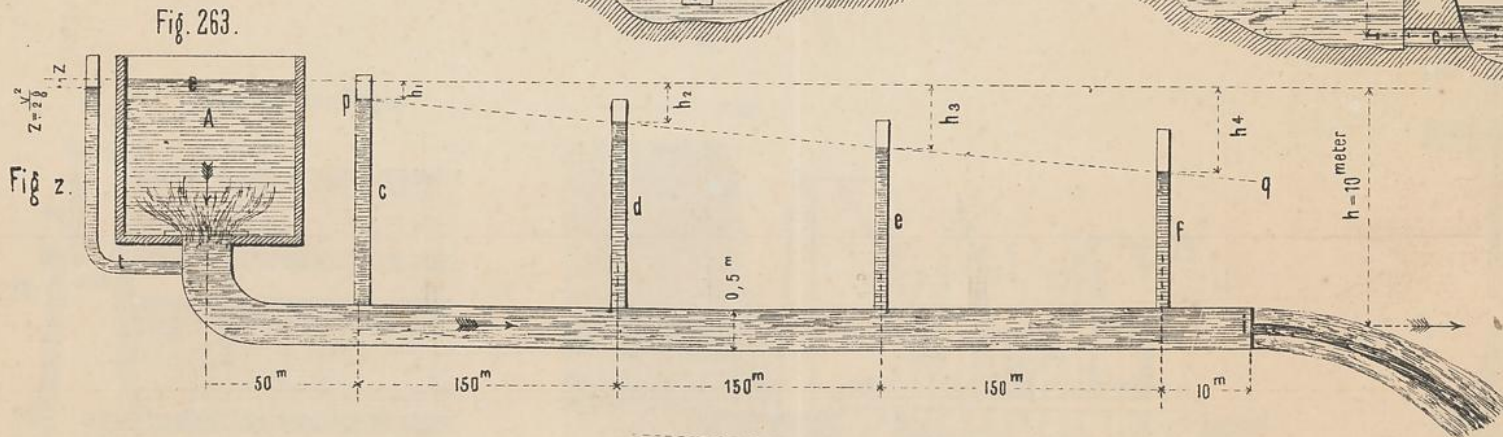
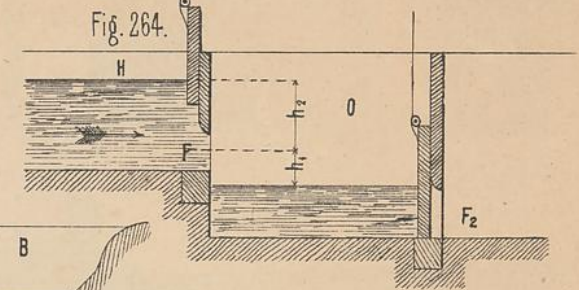
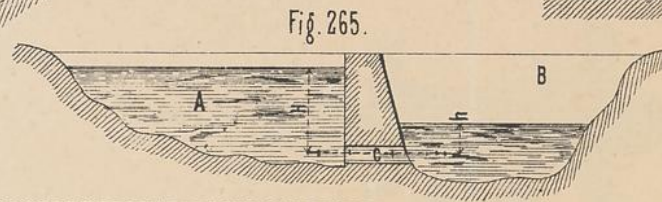
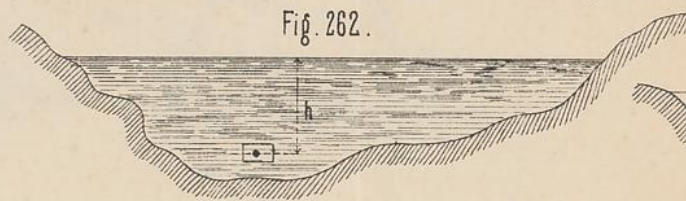
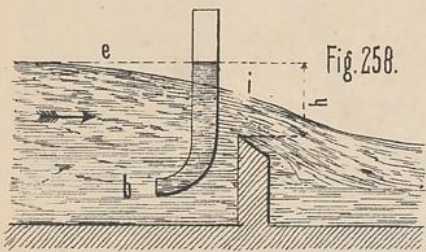
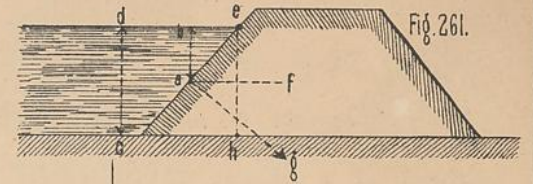
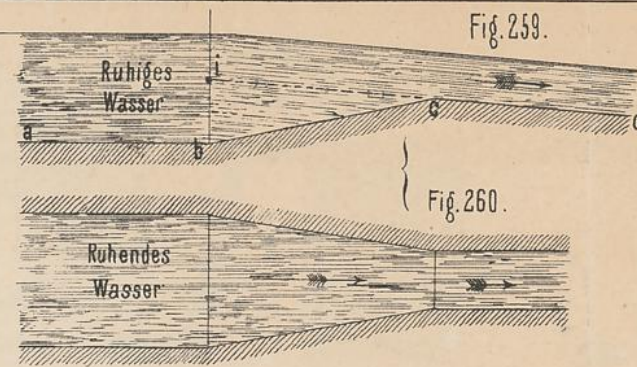
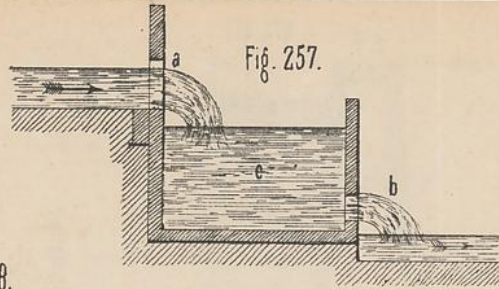
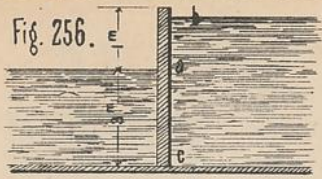

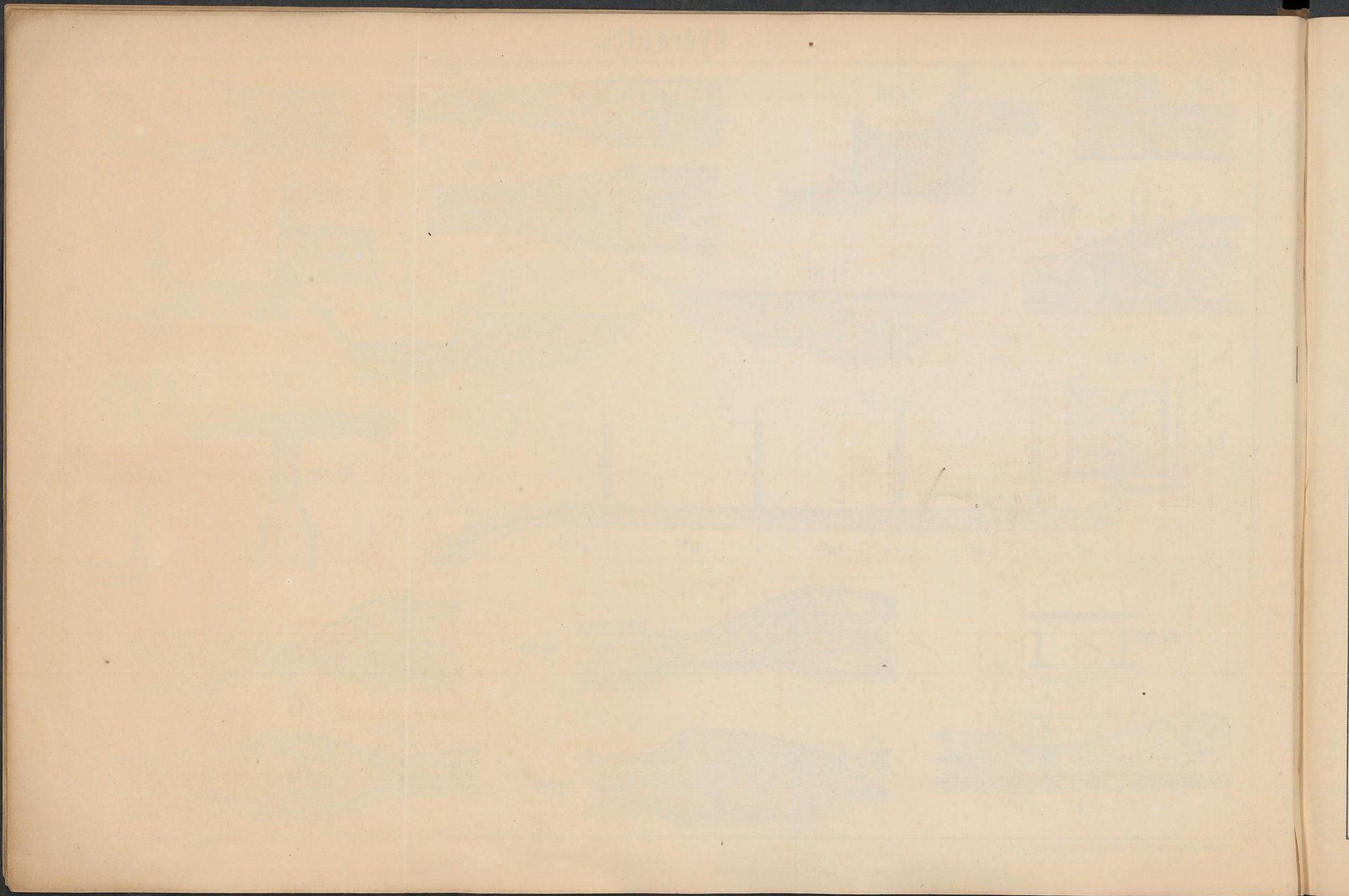

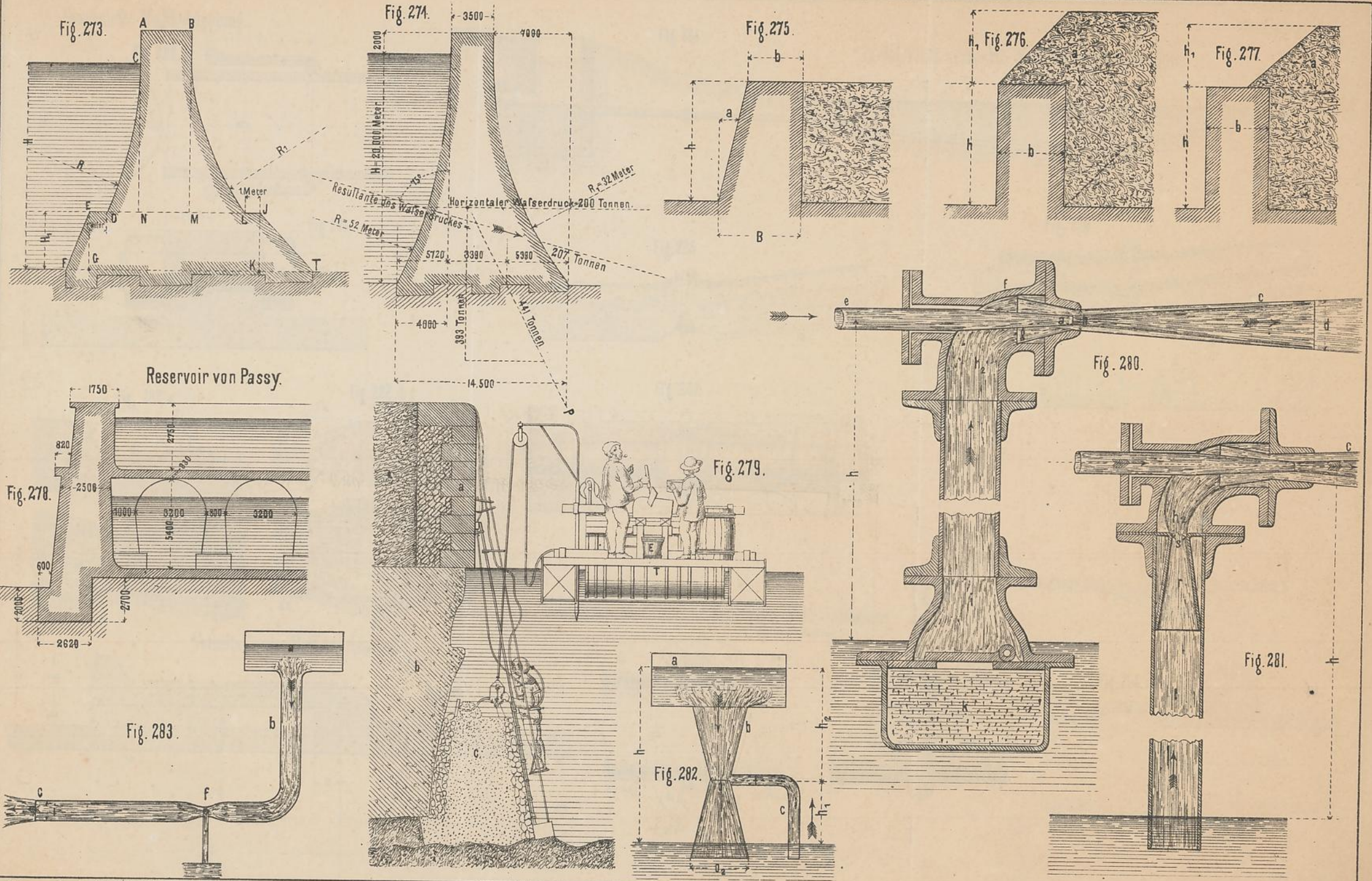

Hydraulic

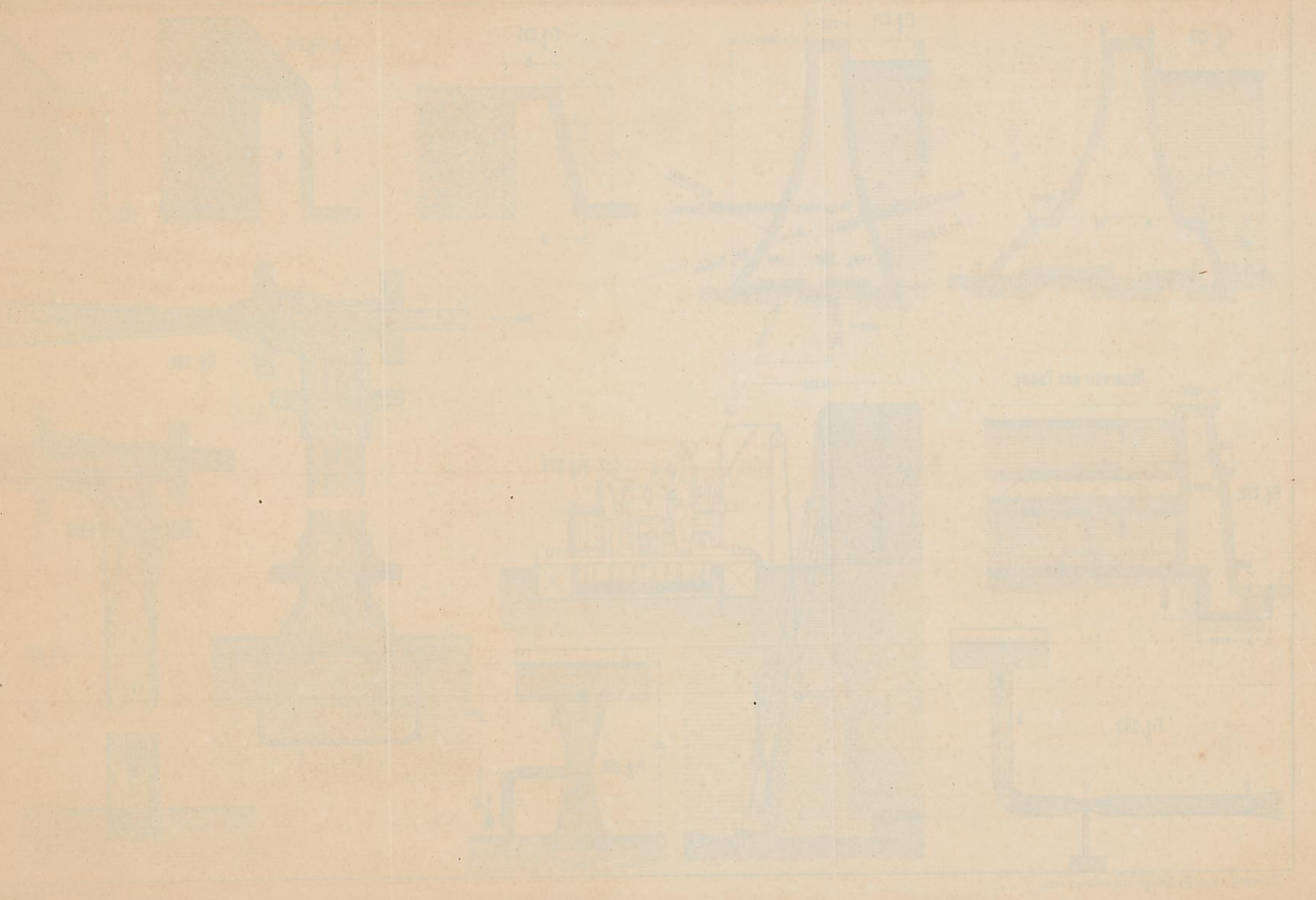

Gewöhnliche Muffenkupplung.

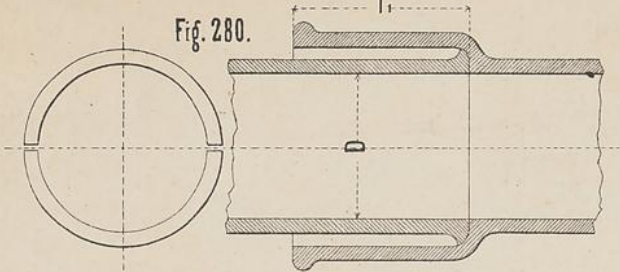

Fig. 280.

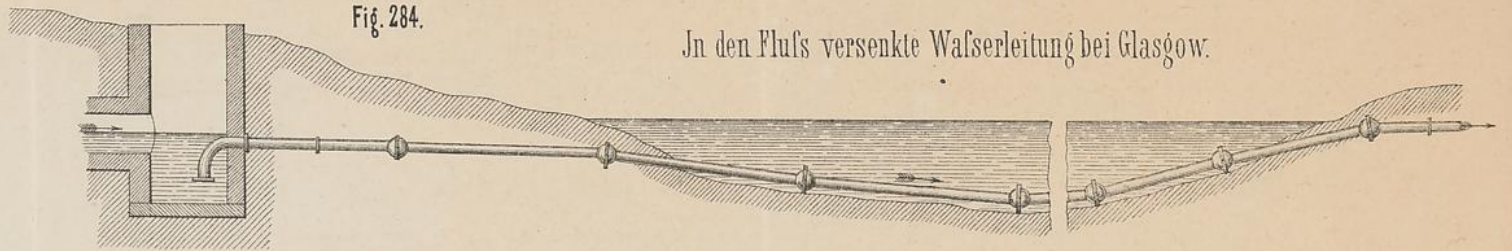

Fig. 284.

In den Fluß versenkte Wasserleitung bei Glasgow.

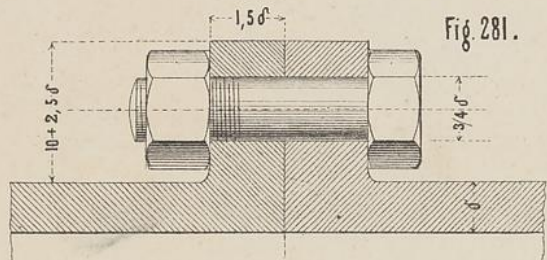

Fig. 281.

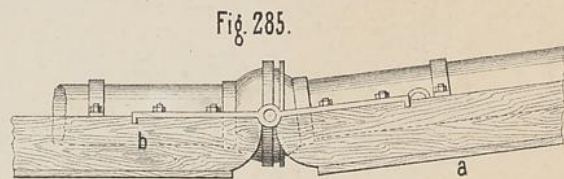

Fig. 285.

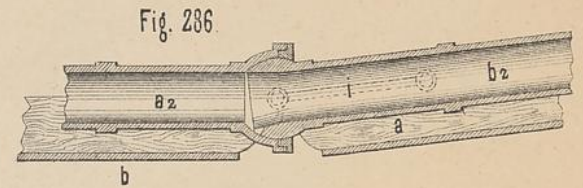

Fig. 286.

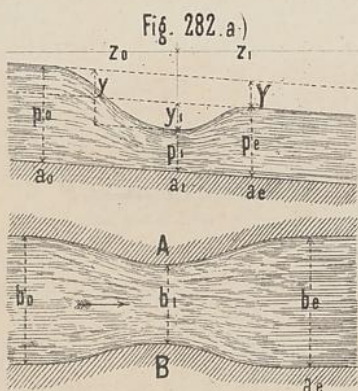

Fig. 282. a.)

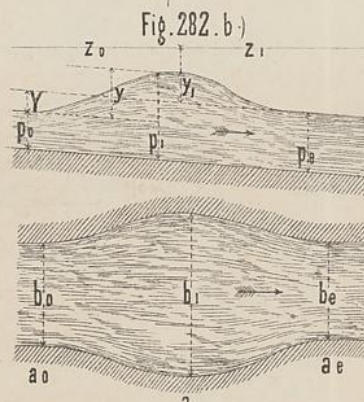

Fig. 282. b.)

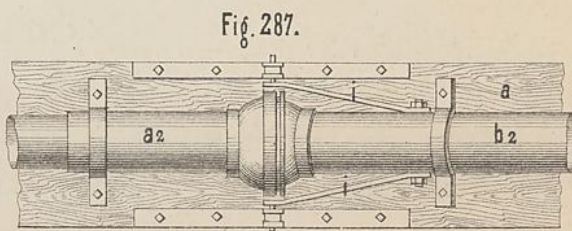

Fig. 287.

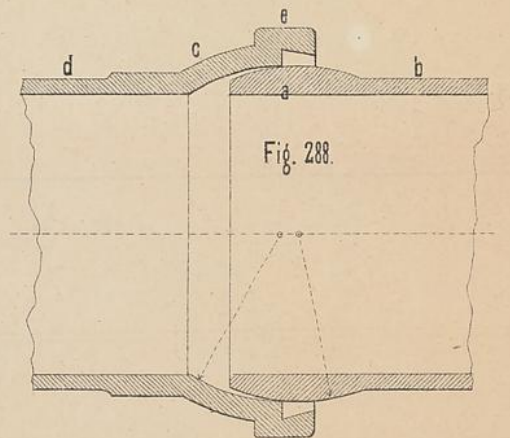

Fig. 288.

Verhältnisse der Muffenverbindung.

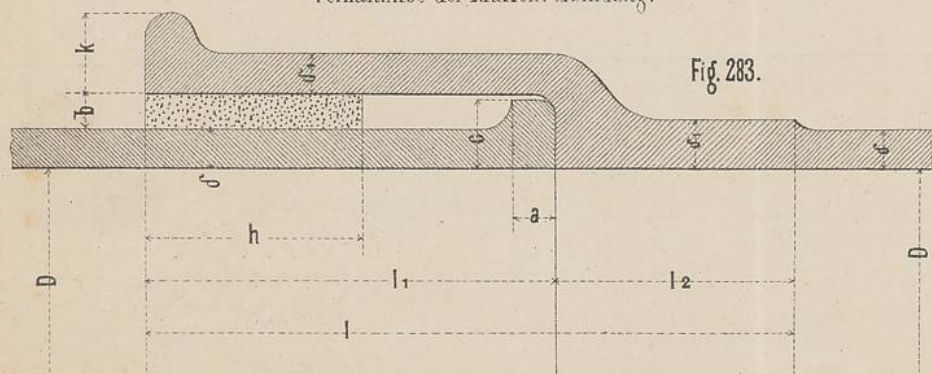

Fig. 283.

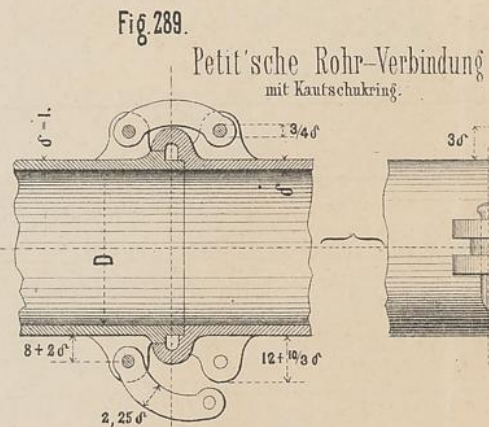

Fig. 289.

Petit'sche Rohr-Verbindung mit Kautschukring.

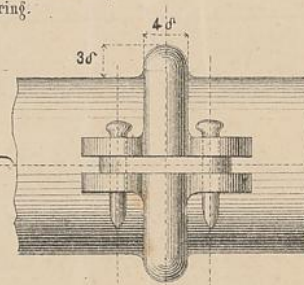

Fig. 290.

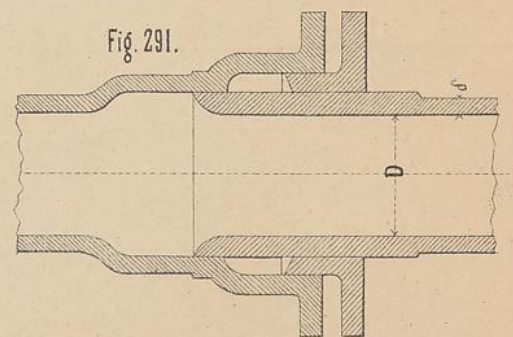
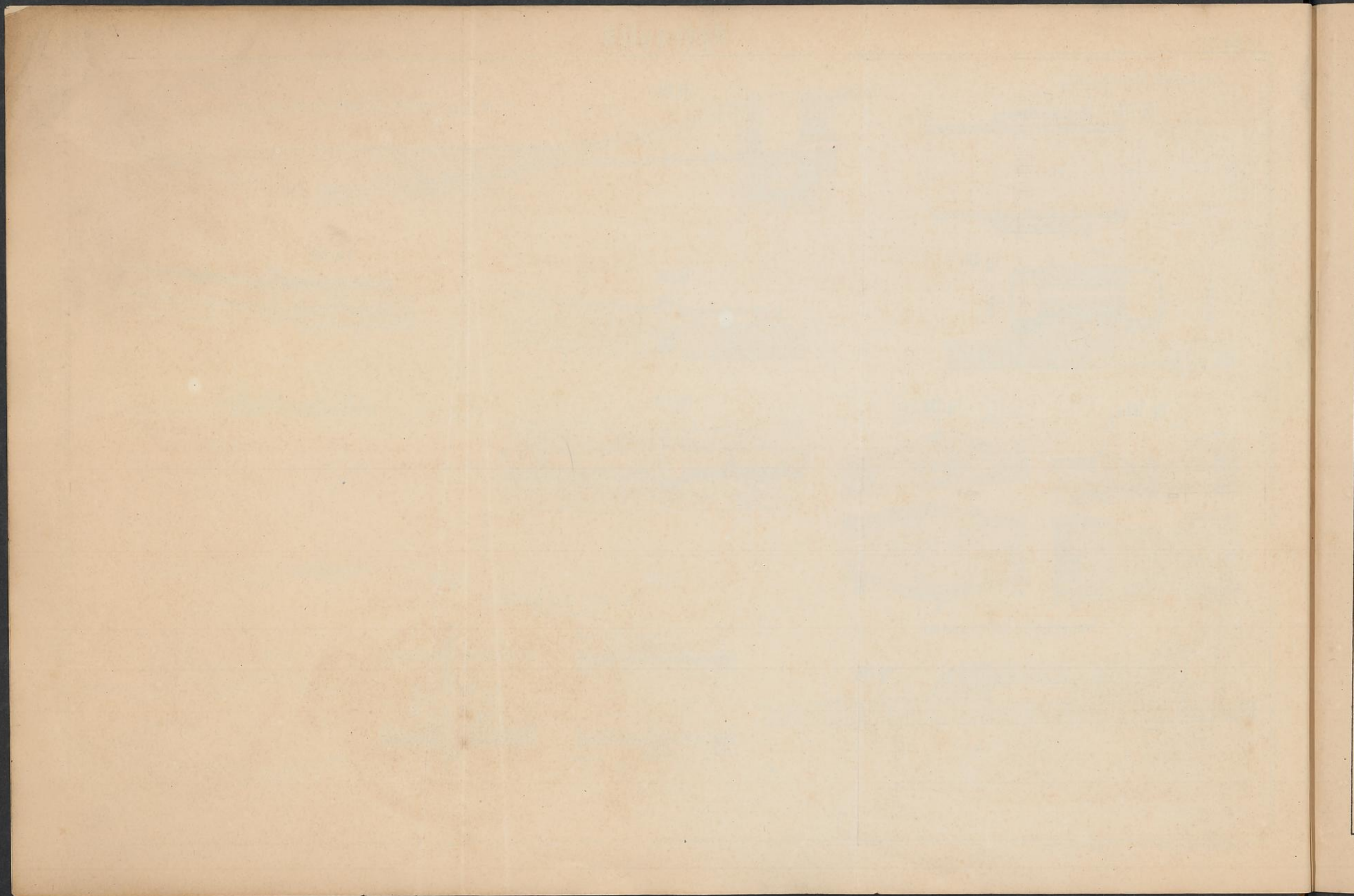

Fig. 291.



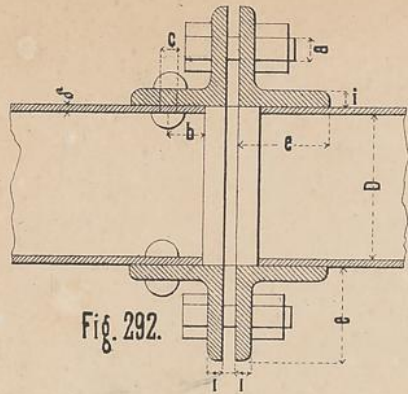

Fig. 292.

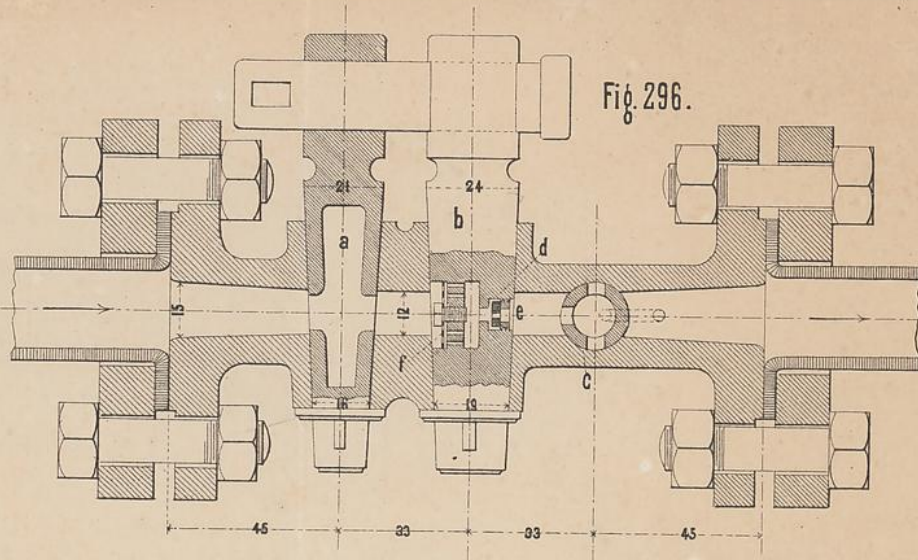

Fig. 296.

Fig. 299.

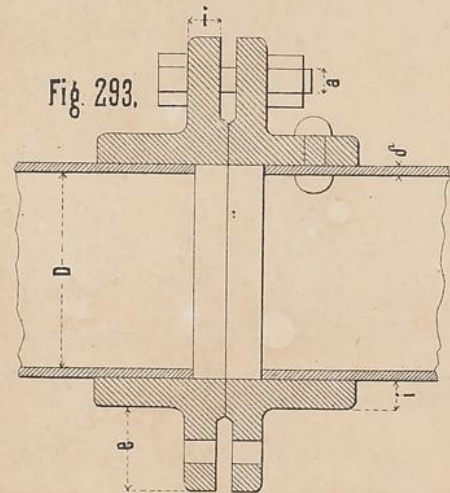
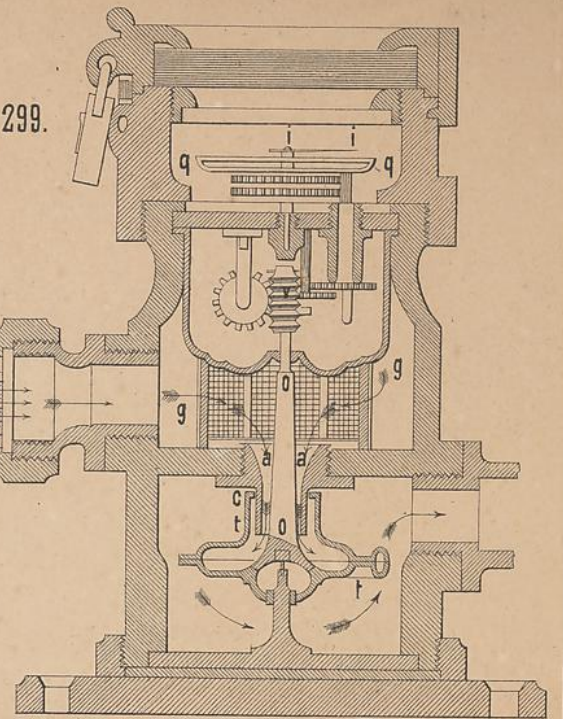

Fig. 293.

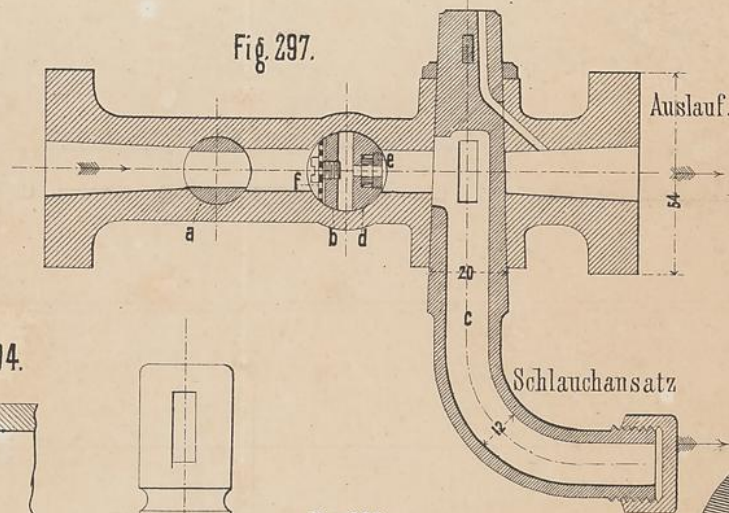

Fig. 297.

Fig. 300.

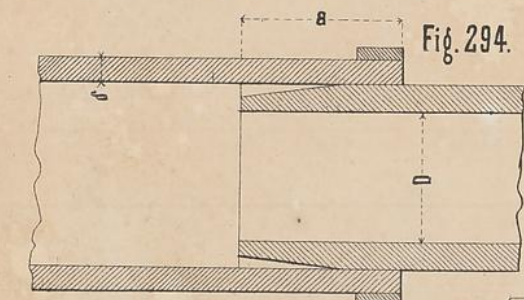
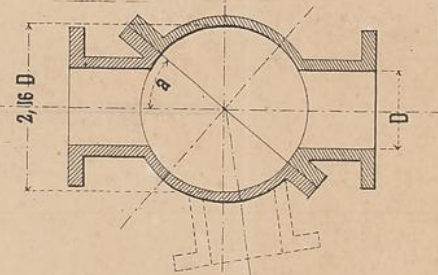

Fig. 294.

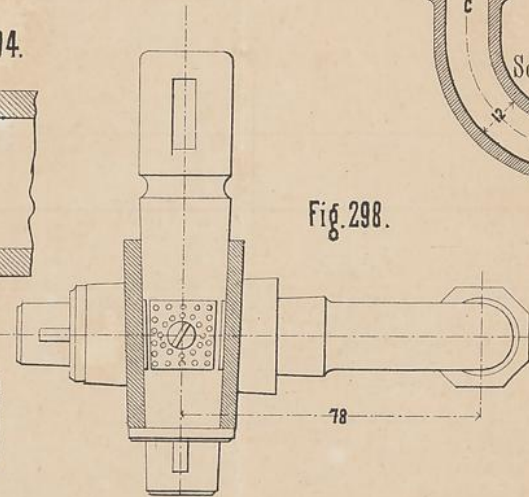

Fig. 298.

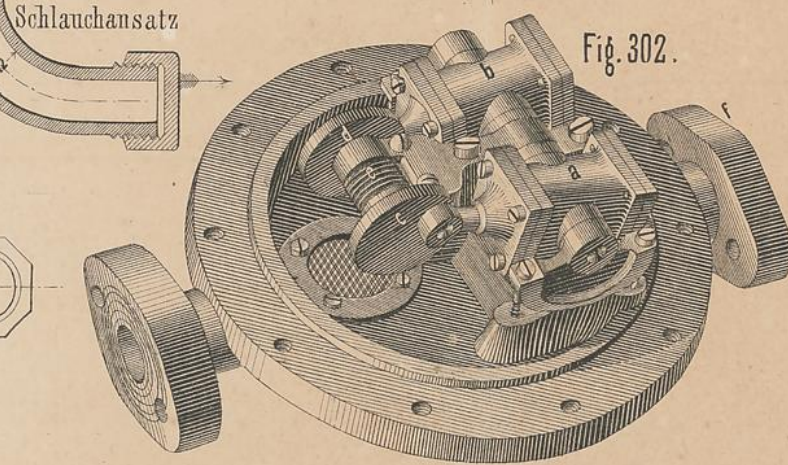

Fig. 302.

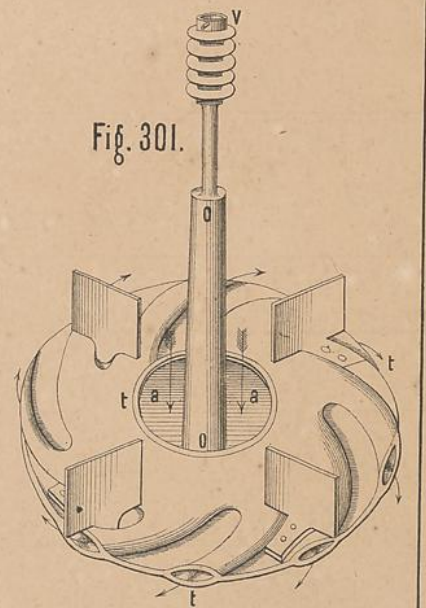

Fig. 301.

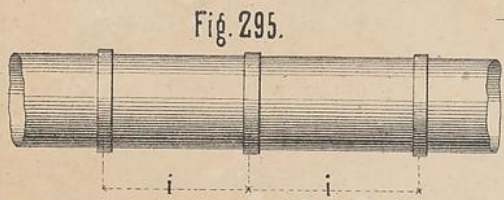
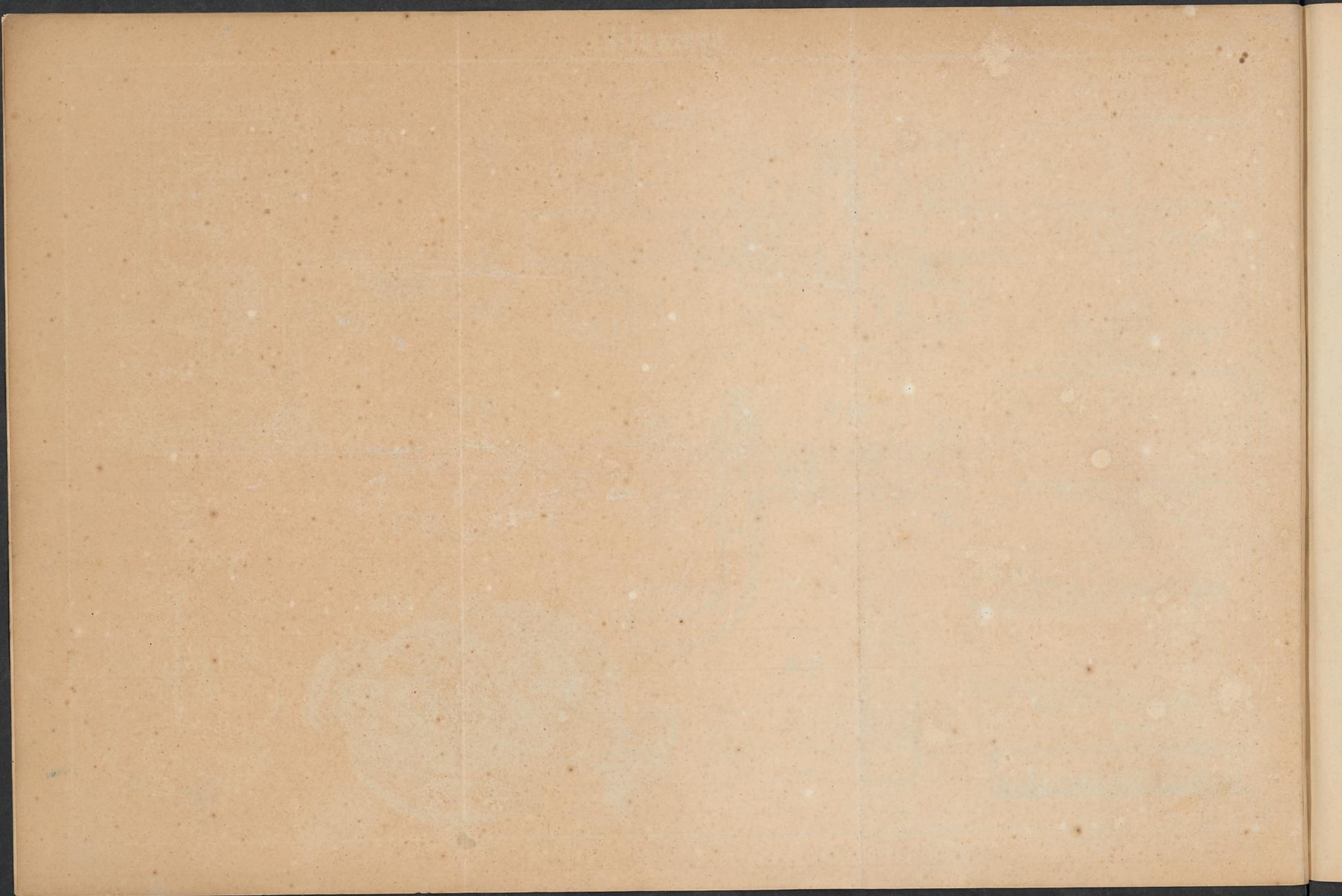
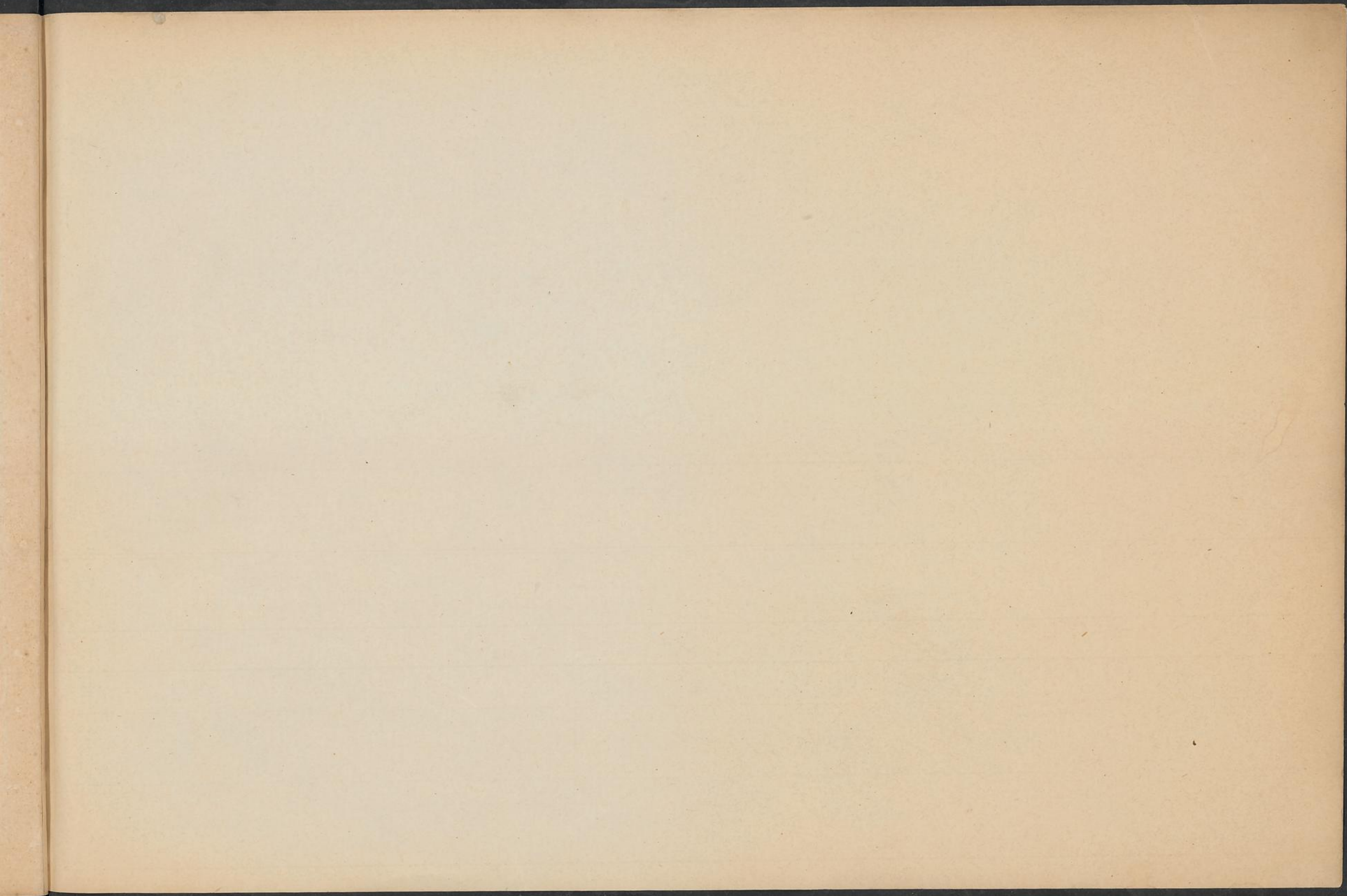

Fig. 295.





ETH Zürich
Bibliothek

4	4795	1	2	*			
Abt. T	Nummer U	Band	Teil	Aufl.	E	S	

0060/1 48052/1

BUCHKARTE
 Bitte nicht herausnehmen!

BUCHBINDEREI
 GEHR. SPETZLER
 ZÜRICH

